

# High-Speed, Fully Differential, Programmable-Gain Amplifier

Check for Samples: [PGA870](#)

## FEATURES

- **Wideband +5-V Operation: 650-MHz Bandwidth**
- **Low Impedance, Voltage Mode Output**
- **Wide Gain Range: –11.5 dB to +20 dB**
- **Precise 0.5-dB Gain Steps**  
**Step-to-Step Gain Error = ±0.03 dB**
- **HD<sub>2</sub>: –93 dBc at 100 MHz**
- **HD<sub>3</sub>: –88 dBc at 100 MHz**
- **IMD<sub>3</sub>: –98 dBc at 100 MHz, –95 dBc at 200 MHz**
- **OIP<sub>3</sub>: +47 dBm at 100 MHz;**  
**Exceeds +45 dBm for Frequencies to 300 MHz**
- **Flexible Gain Control Interface:**
  - Supports latched and unlatched options
  - Gain may be set in power-down state
  - Fast setup and hold times: 2.5 ns
- **Low Disable Current: 2 mA**
- **Pb-Free (RoHS-Compliant) and Green Package**

## APPLICATIONS

- **Programmable Gain IF Amplifier:**
  - Differential signal chains
  - Single-ended to differential conversion
- **Fast Gain Control Loops for:**
  - Test/measurement
  - Digital radio signal chains
- **ADC Driver for Wireless Base Station Signal Chains: GSM, WCDMA, MC-GSM**
- **Radar/Ranging Systems**

## DESCRIPTION

The PGA870 is a wideband programmable-gain amplifier (PGA) for high-speed signal chain and data acquisition systems. The PGA870 has been optimized to provide high bandwidth, low distortion, and low noise, making it ideally suited as a 14-bit analog-to-digital converter (ADC) driver for wireless base station signal chain applications. The wide gain range of –11.5 dB to +20 dB can be adjusted in 0.5-dB gain steps through a 6-bit control word applied to the parallel interface. The gain control interface may be configured as a level-triggered latch or an edge-triggered latch, or it may be placed in an unlatched (transparent) mode. In addition to the 6-bit gain control, the PGA870 contains a power-down pin (PD) that can be used to put the device into a low-current, power-down mode. In this mode, the quiescent current drops to 2 mA, but the gain control circuitry remains active, allowing the gain of the PGA870 to be set before device power-up. The PGA870 is offered in a QFN-28 PowerPAD™ package.

## RELATED PRODUCTS

DEVICE	DESCRIPTION
<a href="#">THS4509</a>	Wideband, low-noise, low-distortion, fully differential amplifier
<a href="#">THS7700</a>	High-speed, fully differential 16-bit ADC driver
<a href="#">THS9000</a>	50-MHz to 400-MHz IF/RF Amplifier
<a href="#">ADS6149</a>	14-Bit, 250-MSPS ADC with DDR LVDS/CMOS Outputs
<a href="#">ADS6145</a>	14-Bit, 125-MSPS ADC with DDR LVDS/CMOS Outputs
<a href="#">ADS58C48</a>	Quad channel IF receiver with SNRBoost 3G

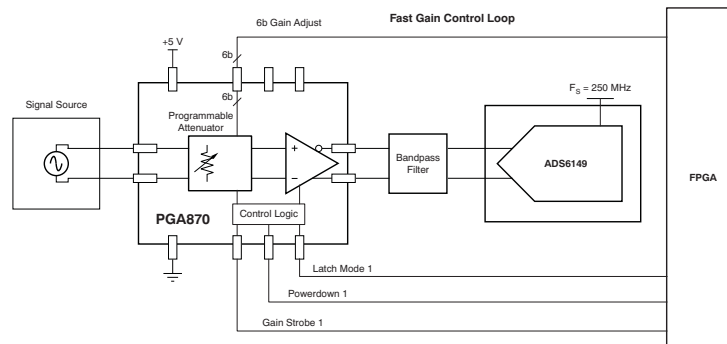

Please be aware that an important notice concerning availability, standard warranty, and use in critical applications of Texas Instruments semiconductor products and disclaimers thereto appears at the end of this data sheet.

PowerPAD is a trademark of Texas Instruments.

All other trademarks are the property of their respective owners.



This integrated circuit can be damaged by ESD. Texas Instruments recommends that all integrated circuits be handled with appropriate precautions. Failure to observe proper handling and installation procedures can cause damage.

ESD damage can range from subtle performance degradation to complete device failure. Precision integrated circuits may be more susceptible to damage because very small parametric changes could cause the device not to meet its published specifications.

### ORDERING INFORMATION<sup>(1)</sup>

PRODUCT	PACKAGE-LEAD	PACKAGE DESIGNATOR	SPECIFIED TEMPERATURE RANGE	PACKAGE MARKING	ORDERING NUMBER	TRANSPORT MEDIA, QUANTITY
PGA870	QFN-28	RHD	–40°C to +85°C	PGA870	PGA870IRHDT	Tape and Reel, 250
				PGA870	PGA870IRHDR	Tape and Reel, 3000

- (1) For the most current package and ordering information see the Package Option Addendum at the end of this document, or see the TI web site at [www.ti.com](http://www.ti.com).

### ABSOLUTE MAXIMUM RATINGS<sup>(1)</sup>

Over operating free-air temperature range, unless otherwise noted.

		PGA870	UNIT
Power supply		6	V
Internal power dissipation		See Thermal Characteristics	
Input voltage range		V <sub>S</sub>	V
Storage temperature range		–65 to +150	°C
Maximum junction temperature (T <sub>J</sub> )		+150	°C
Maximum junction temperature (T <sub>J</sub> ), continuous operation, long-term reliability		+140	°C
ESD rating	Human body model (HBM)	2000	V
	Charged device model (CDM)	1000	V
	Machine model (MM)	200	V

- (1) Stresses above these ratings may cause permanent damage. Exposure to absolute maximum conditions for extended periods may degrade device reliability. These are stress ratings only, and functional operation of the device at these or any other conditions beyond those specified is not supported.

### DISSIPATION RATINGS<sup>(1)</sup>

PACKAGE	$\theta_{JP}$ (°C/W)	$\theta_{JA}$ (°C/W)	POWER RATING <sup>(2)</sup> (T <sub>J</sub> = +125°C)	
			T <sub>A</sub> = +25°C	T <sub>A</sub> = +85°C
QFN-28	4.1	35	2.9 W	0.87 W

- (1) These data were taken with the JEDEC High-K test PCB. For the JEDEC low-K test PCB,  $\theta_{JA}$  is 350°C/W.  
 (2) Power rating is determined with a junction temperature of +125°C. This is the point where distortion starts to substantially increase and long-term reliability starts to be reduced. Thermal management of the final printed circuit board should strive to keep the junction temperature at or below +125°C for best performance and reliability.

**ELECTRICAL CHARACTERISTICS:  $V_{S+} = +5\text{ V}$** 
**Boldface limits are tested at +25°C.**

 At  $T_A = +25^\circ\text{C}$ ,  $V_{S+} = +5\text{ V}$ , differential input signal, differential  $V_{OUT} = 2 V_{PP}$ ,  $R_L = 200\ \Omega$  differential,  $G = 20\text{ dB}$ , and input and output common-mode at internal midsupply reference, unless otherwise noted.

PARAMETER	CONDITIONS		PGA870IRHD			UNITS	TEST LEVEL <sup>(1)</sup>	
			MIN	TYP	MAX			
<b>AC PERFORMANCE</b>								
Small-signal bandwidth	$G = 20\text{ dB}$ , $V_O = 100\text{ mV}_{PP}$			650		MHz	C	
Large-signal bandwidth	$G = 20\text{ dB}$ , $V_O = 2\text{ V}_{PP}$			650		MHz	C	
Bandwidth for 0.1-dB flatness				100		MHz	C	
Slew rate (differential)	2-V step			2900		V/ $\mu\text{s}$	C	
Rise time	2-V step			0.55		ns	C	
Fall time	2-V step			0.55		ns	C	
Settling time to 1%	2-V step			3		ns	C	
Settling time to 0.1%	2-V step			5		ns	C	
Noise figure	150- $\Omega$ system, Gain = +20 dB, $f = 100\text{ MHz}$			13		dB	C	
Output-referred voltage noise	Gain = +20 dB, $f > 1\text{ MHz}$			30		nV/ $\sqrt{\text{Hz}}$	C	
	Gain = -11 dB, $f > 1\text{ MHz}$			40		nV/ $\sqrt{\text{Hz}}$	C	
<b>HARMONIC DISTORTION</b>								
<b>Gain = +20 dB, <math>V_O = 2\text{ V}_{PP}</math>, <math>R_L = 200\ \Omega</math></b>								
Second-order harmonic distortion	$f = 50\text{ MHz}$			-108		dBc	C	
	$f = 100\text{ MHz}$			-93		dBc	C	
	$f = 200\text{ MHz}$			-71		dBc	C	
Third-order harmonic distortion	$f = 50\text{ MHz}$			-95		dBc	C	
	$f = 100\text{ MHz}$			-88		dBc	C	
	$f = 200\text{ MHz}$			-75		dBc	C	
Second-order intermodulation distortion	2-MHz tone spacing	$f_1(\text{MHz})$	$f_2(\text{MHz})$				C	
		49	51		-87	dBc	C	
		99	101		-90	dBc	C	
Third-order intermodulation distortion	2-MHz tone spacing	49	51		-103	dBc	C	
		99	101		-98	dBc	C	
		199	201		-95	dBc	C	
Output third-order intercept	$V_{OUT} = 2\text{ V}_{PP}$ , $R_L = 200\ \Omega$	49	51		50	dBm	C	
		99	101		47	dBm	C	
		199	201		45	dBm	C	
<b>DC</b>								
Output offset voltage	$T_A = +25^\circ\text{C}$			<b>-30</b>	$\pm 5$	<b>30</b>	mV	A
	$T_A = -40^\circ\text{C}$ to $+85^\circ\text{C}$			-35		35	mV	B
Average offset voltage drift	$T_A = -40^\circ\text{C}$ to $+85^\circ\text{C}$			20		$\mu\text{V}/^\circ\text{C}$	B	
<b>INPUT</b>								
Input return loss	$Z_{SYS} = 150\ \Omega$ , frequency < 300MHz			-40		dB	B	
Differential input resistance			129	150	173	$\Omega$	B	
Differential input capacitance				1.2		pF	C	
Single-ended input resistance				141		$\Omega$	B	
Common-mode rejection ratio	$T_A = +25^\circ\text{C}$ , Gain = 20 dB		<b>54</b>	76		dB	A	

(1) Test levels: **(A)** 100% tested at +25°C. Over temperature limits set by characterization and simulation. **(B)** Limits set by characterization and simulation. **(C)** Typical value; only for information.

**ELECTRICAL CHARACTERISTICS:  $V_{S+} = +5\text{ V}$  (continued)**
**Boldface limits are tested at +25°C.**

 At  $T_A = +25^\circ\text{C}$ ,  $V_{S+} = +5\text{ V}$ , differential input signal, differential  $V_{OUT} = 2 V_{PP}$ ,  $R_L = 200\ \Omega$  differential,  $G = 20\text{ dB}$ , and input and output common-mode at internal midsupply reference, unless otherwise noted.

PARAMETER	CONDITIONS	PGA870IRHD			UNITS	TEST LEVEL <sup>(1)</sup>
		MIN	TYP	MAX		
<b>OUTPUT</b>						
Maximum output voltage high	Each output with 100 $\Omega$ to midsupply	$T_A = +25^\circ\text{C}$	3.5	3.7	V	A
		$T_A = -40^\circ\text{C}$ to $+85^\circ\text{C}$	3.4		V	B
Minimum output voltage low		$T_A = +25^\circ\text{C}$		1.3	V	A
		$T_A = -40^\circ\text{C}$ to $+85^\circ\text{C}$			1.6	V
Differential output voltage swing	$T_A = +25^\circ\text{C}$ , $R_L = 200\ \Omega$	4	4.8	$V_{PP}$	B	
	$T_A = -40^\circ\text{C}$ to $+85^\circ\text{C}$	3.6		$V_{PP}$	B	
Differential output current drive	$T_A = +25^\circ\text{C}$ , $R_L = 20\ \Omega$	<b>40</b>	50	$\text{mA}_P$	A	
Output common-mode offset from midsupply	$T_A = +25^\circ\text{C}$ , $R_L = 20\ \Omega$	<b>-60</b>	$\pm 10$	<b>60</b>	mV	A
Differential output impedance	$f = 100\text{ MHz}$		3.5 / 87	$\Omega / ^\circ$	B	
Differential output impedance model	Series $R_{OUT,EQ}$ , $L_{OUT,EQ}$		0.3 / 3.8	$\Omega / \text{nH}$	B	
<b>POWER SUPPLY</b>						
Specified operating voltage		4.75	5	5.25	V	C
Quiescent current	$T_A = +25^\circ\text{C}$	<b>138</b>	143	<b>148</b>	mA	A
	$T_A = -40^\circ\text{C}$ to $+85^\circ\text{C}$	136		150	mA	B
Power-supply rejection ratio (PSRR)	$T_A = +25^\circ\text{C}$ , Gain = 20 dB <sup>(2)</sup>	<b>54</b>	76		dB	A
<b>POWER DOWN</b>						
Device power-up voltage threshold	Ensured on above 2.1 V	<b>2.1</b>			V	A
Device power-down voltage threshold	Ensured off below 0.9 V			<b>0.9</b>	V	A
Power-down quiescent current	$T_A = +25^\circ\text{C}$		2	<b>4</b>	mA	A
	$T_A = -40^\circ\text{C}$ to $+85^\circ\text{C}$			4.8	mA	B
Forward isolation in power-down state	$f = 100\text{ MHz}$		-110		dB	C
$\overline{\text{PD}}$ pin input bias current	$P_D = V_{S-}$		0.5		$\mu\text{A}$	B
$\overline{\text{PD}}$ pin input impedance			20    0.5		$\text{k}\Omega$    $\text{pF}$	C
Turn-on time delay	Measured to output on		16		ns	C
Turn-off time delay	Measured to output off		60		ns	C
<b>GAIN SETTING</b>						
Gain range		<b>-11.5</b>		<b>+20</b>	dB	A
Gain control: G0 to G5			6		Bits	B
Gain step size	$-11.5\text{ dB} \leq \text{Gain} \leq +20\text{ dB}$		<b>0.50</b>		dB	A
Gain error over entire gain range	Absolute gain error	<b>-0.35</b>	$\pm 0.05$	<b>0.35</b>	dB	A
	Step to step gain error	<b>-0.10</b>	$\pm 0.03$	<b>0.10</b>	dB	A
Gain temp coefficient		0.0018	0.0022	0.0026	$\text{dB}/^\circ\text{C}$	B
Gain settling time		5			ns	B
<b>DIGITAL INPUTS B0 to B5 and Latch</b>						
Digital threshold low				<b>0.9</b>	V	A
Digital threshold high		<b>2.1</b>			V	A
Current into/out of digital pins			$\pm 20$		nA	C
Data set up time to GAIN STROBE low			2.5		ns	C
Data hold time after GAIN STROBE low			0		ns	C
Latency time			6.4		ns	C

(2) PSRR is defined with respect to a differential output.

### PIN CONFIGURATION

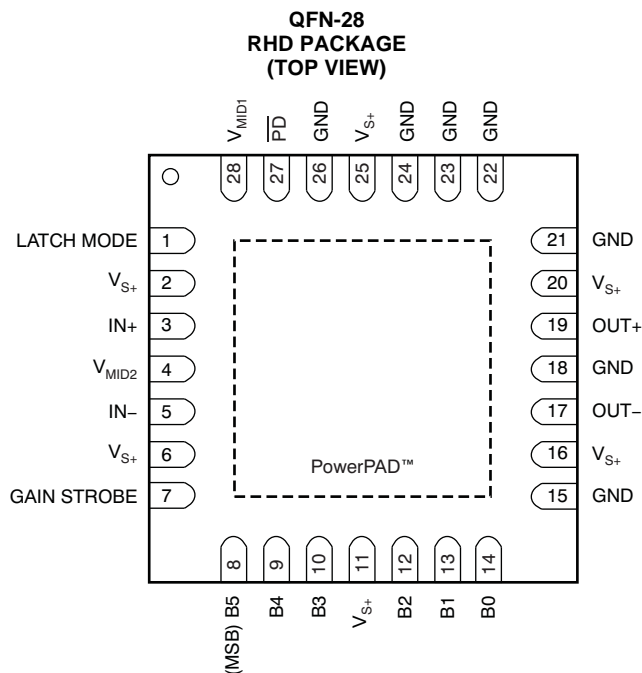

### PIN ASSIGNMENTS

PIN NUMBER	PIN NAME	DESCRIPTION
1	LATCH MODE	Controls latched and unlatched acquisition of the gain control word (B0 to B5). See the application section <a href="#">Gain Control Modes</a> for a detailed description.
2, 6, 11, 16, 20, 25	V <sub>S+</sub>	+5V power supply
3	IN+	Noninverting input
4	V <sub>MID2</sub>	Buffer output for the internal midsupply reference. This point is the output of an active buffer which is not intended to drive an external load. It should be bypassed by a 0.1-μF capacitor.
5	IN-	Inverting input
7	GAIN STROBE	Gain latch clock pin
8	B5 (MSB)	Gain control MSB
9	B4	Gain control bit 4
10	B3	Gain control bit 3
12	B2	Gain control bit 2
13	B1	Gain control bit 1
14	B0 (LSB)	Gain control bit 0
17	OUT-	Inverting output
15, 18, 21, 22, 23, 24, 26	GND	Ground
19	OUT+	Noninverting output
27	$\overline{\text{PD}}$	Active low power-down for device analog circuitry. Gain control CMOS circuitry is still active when $\overline{\text{PD}}$ is low.
28	V <sub>MID1</sub>	Chip bypass pin for internal midsupply reference. This point is the midpoint of a resistive voltage divider and is not intended to function as an input. It should be bypassed with a 0.1-μF capacitor.
Thermal Pad	PowerPAD	Thermal contact for heat dissipation. The thermal pad must be connected to electrical ground.

**TYPICAL CHARACTERISTICS**

At  $T_A = +25^\circ\text{C}$ ,  $V_{S+} = +5\text{ V}$ , differential input signal, differential  $V_{OUT} = 2\text{ V}_{PP}$ ,  $R_L = 200\ \Omega$  differential,  $G = +20\text{ dB}$ , and input and output common-mode at internal midsupply reference, unless otherwise noted.

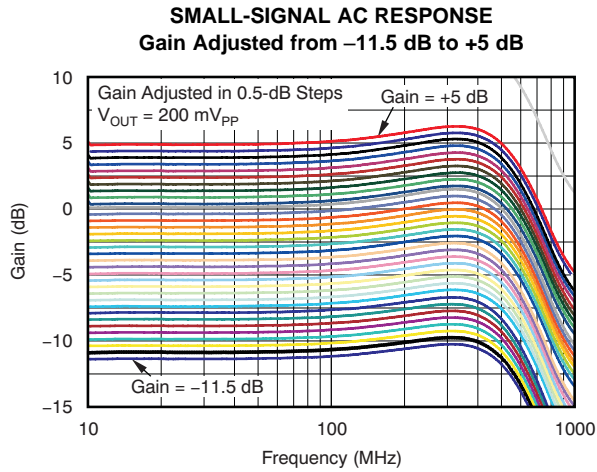

Figure 1.

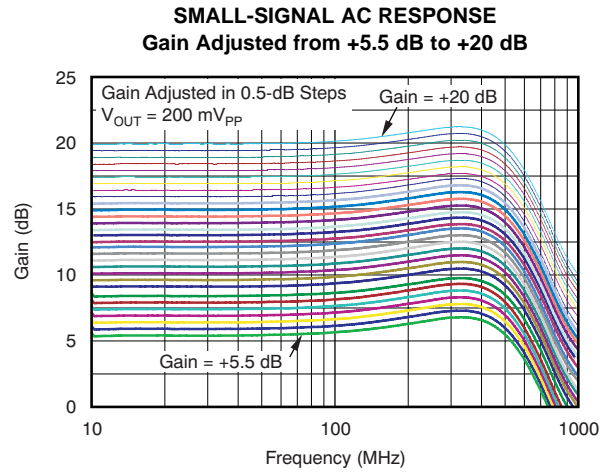

Figure 2.

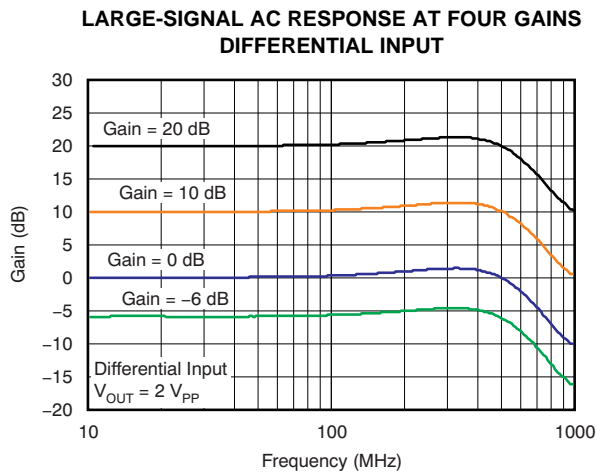

Figure 3.

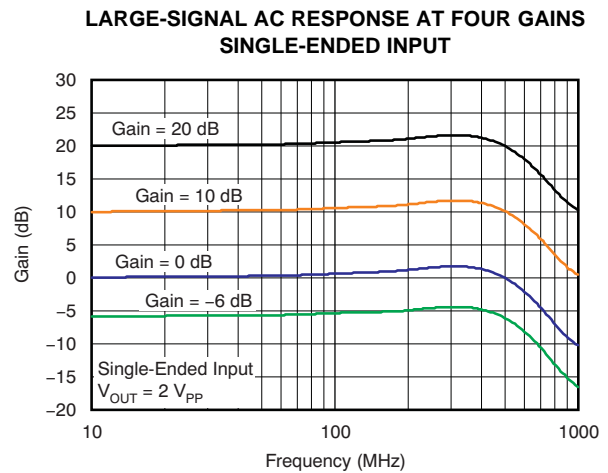

Figure 4.

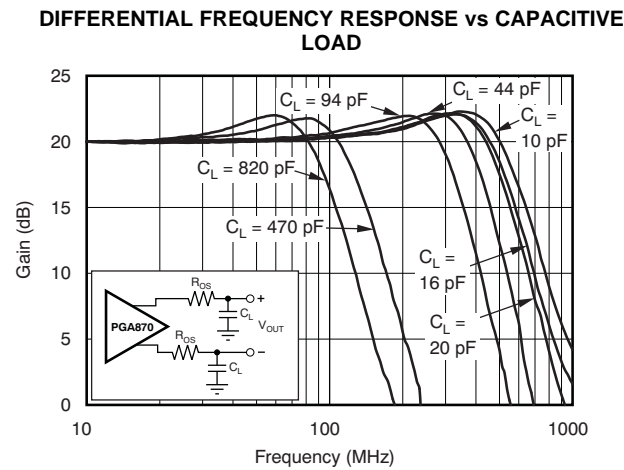

Figure 5.

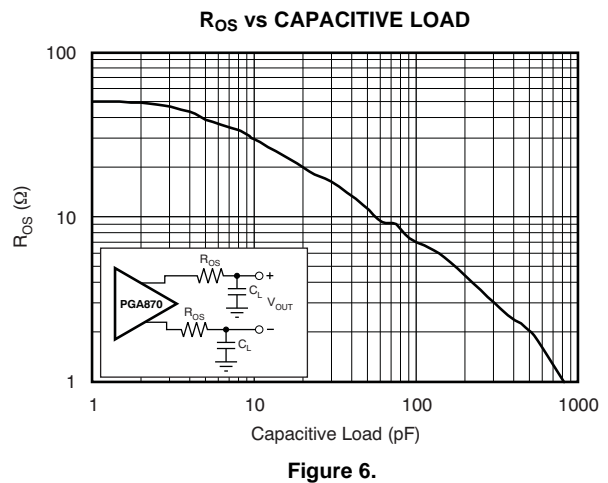

Figure 6.

**TYPICAL CHARACTERISTICS (continued)**

At  $T_A = +25^\circ\text{C}$ ,  $V_{S+} = +5\text{ V}$ , differential input signal, differential  $V_{OUT} = 2 V_{PP}$ ,  $R_L = 200\ \Omega$  differential,  $G = +20\text{ dB}$ , and input and output common-mode at internal midsupply reference, unless otherwise noted.

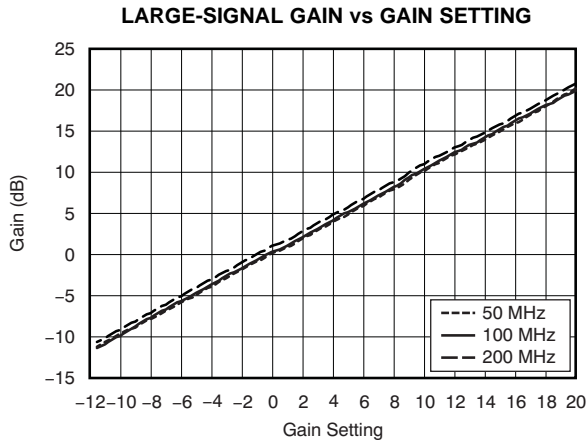

Figure 7.

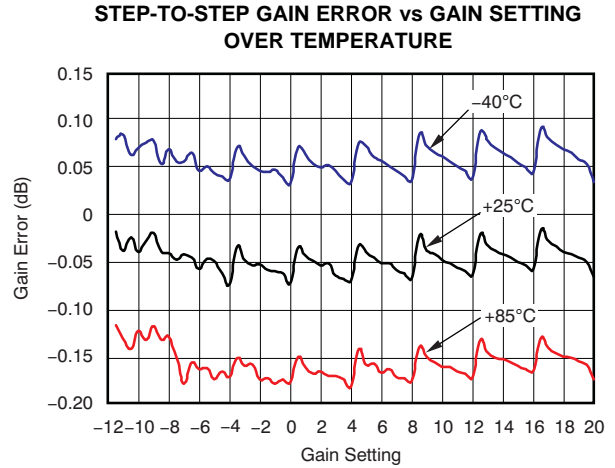

Figure 8.

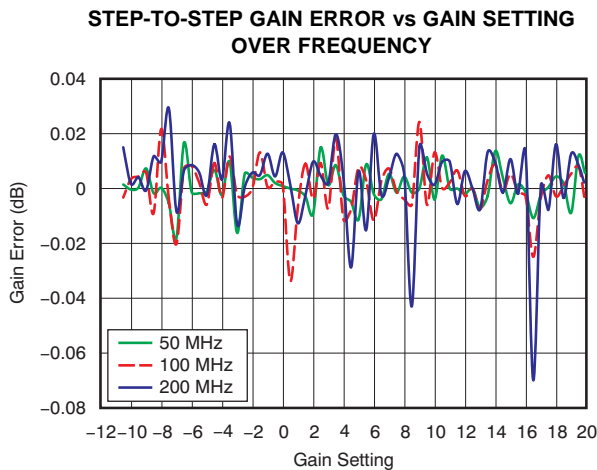

Figure 9.

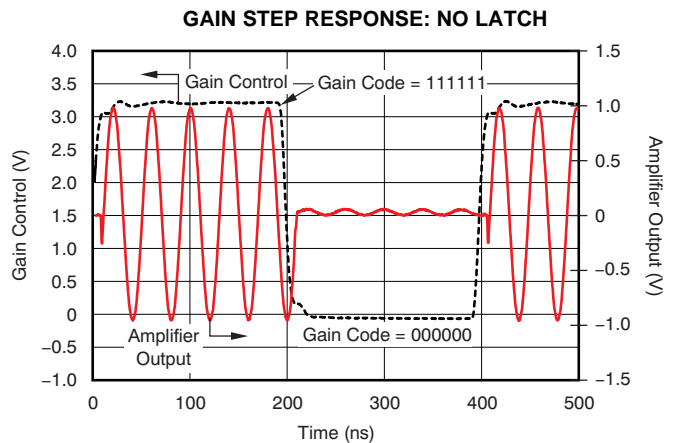

Figure 10.

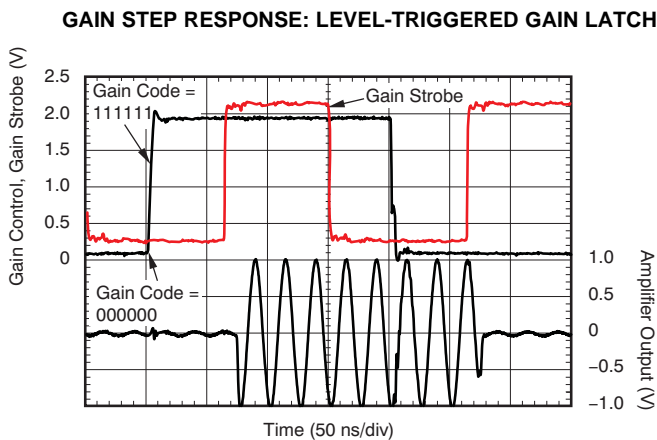

Figure 11.

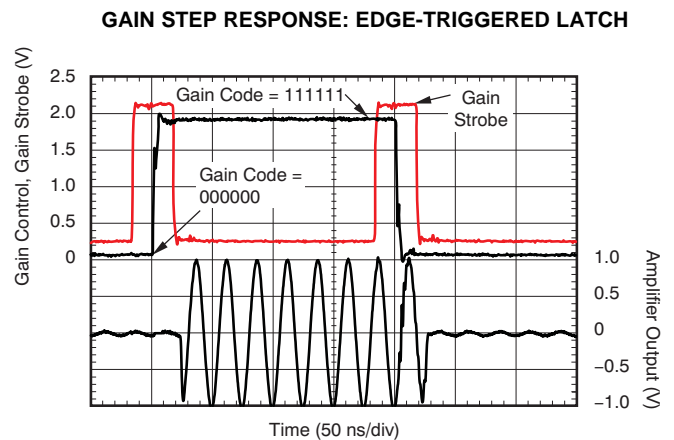

Figure 12.

**TYPICAL CHARACTERISTICS (continued)**

At  $T_A = +25^\circ\text{C}$ ,  $V_{S+} = +5\text{ V}$ , differential input signal, differential  $V_{OUT} = 2 V_{PP}$ ,  $R_L = 200\ \Omega$  differential,  $G = +20\text{ dB}$ , and input and output common-mode at internal midsupply reference, unless otherwise noted.

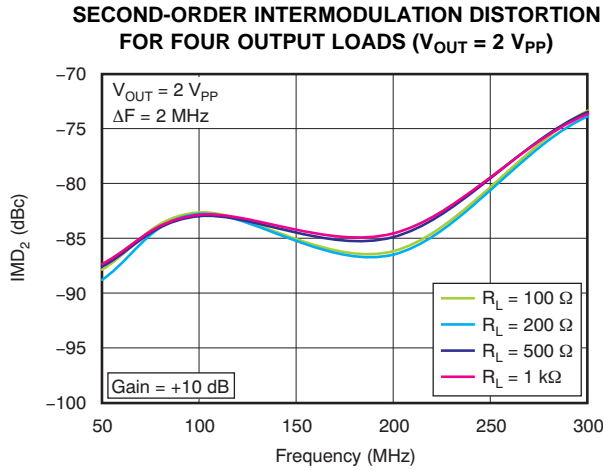

Figure 13.

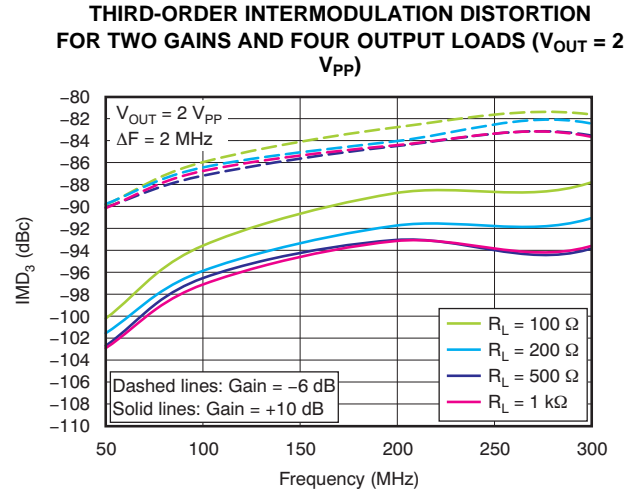

Figure 14.

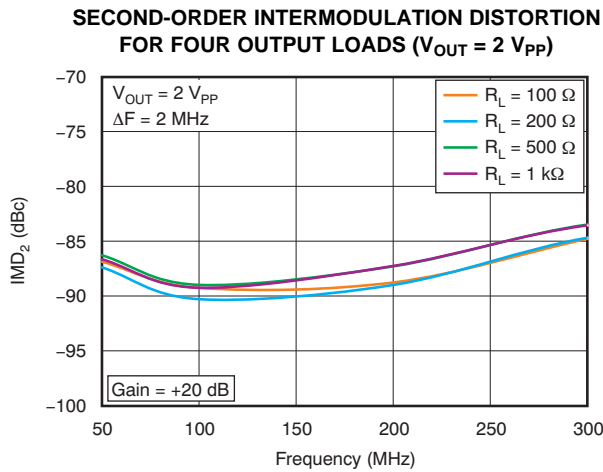

Figure 15.

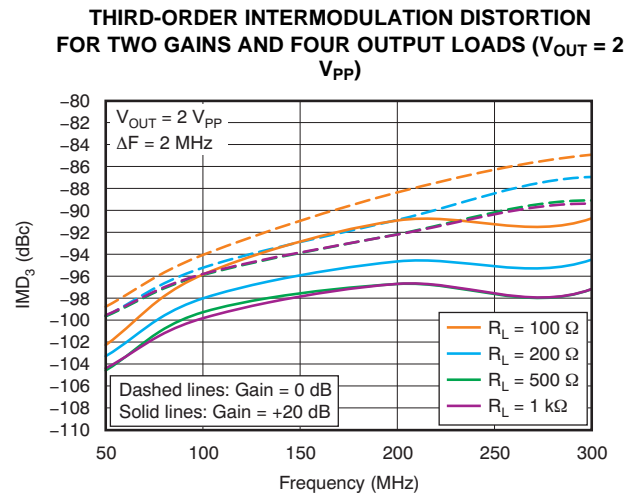

Figure 16.

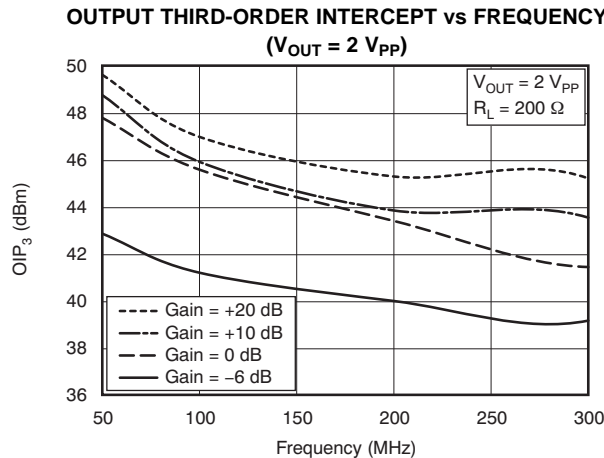

Figure 17.

**TYPICAL CHARACTERISTICS (continued)**

At  $T_A = +25^\circ\text{C}$ ,  $V_{S+} = +5\text{ V}$ , differential input signal, differential  $V_{OUT} = 2 V_{PP}$ ,  $R_L = 200\ \Omega$  differential,  $G = +20\text{ dB}$ , and input and output common-mode at internal midsupply reference, unless otherwise noted.

**SECOND-ORDER INTERMODULATION DISTORTION FOR FOUR OUTPUT LOADS ( $V_{OUT} = 3 V_{PP}$ )**

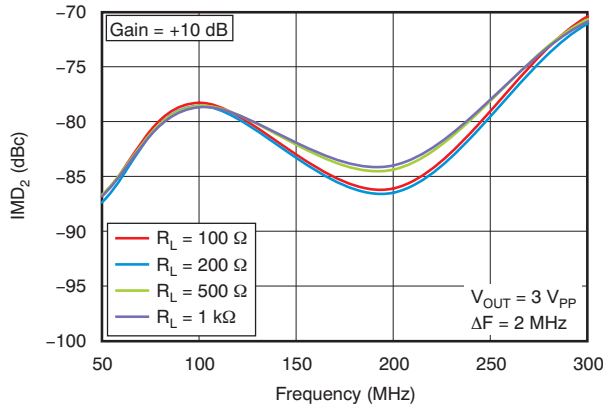

Figure 18.

**THIRD-ORDER INTERMODULATION DISTORTION FOR TWO GAINS AND FOUR OUTPUT LOADS ( $V_{OUT} = 3 V_{PP}$ )**

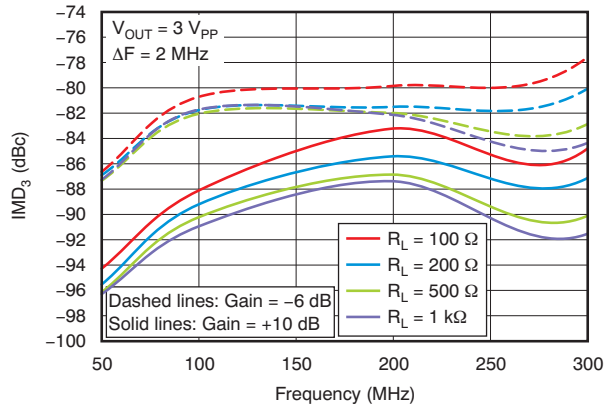

Figure 19.

**SECOND-ORDER INTERMODULATION DISTORTION FOR FOUR OUTPUT LOADS ( $V_{OUT} = 3 V_{PP}$ )**

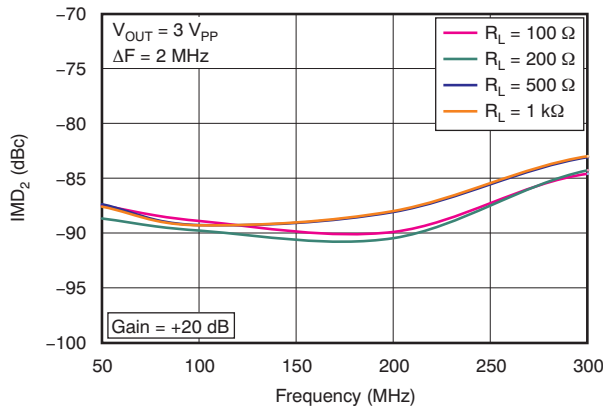

Figure 20.

**THIRD-ORDER INTERMODULATION DISTORTION FOR TWO GAINS AND FOUR OUTPUT LOADS ( $V_{OUT} = 3 V_{PP}$ )**

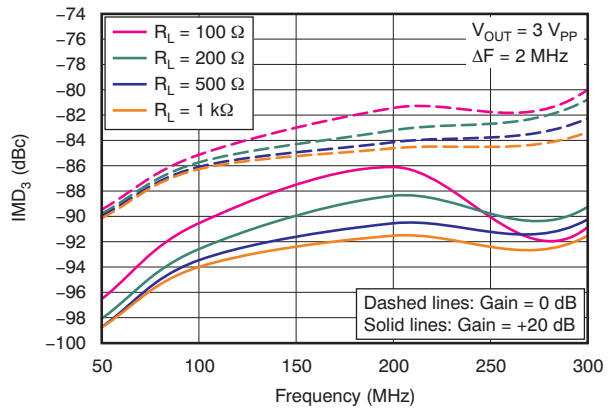

Figure 21.

**OUTPUT THIRD-ORDER INTERCEPT vs FREQUENCY ( $V_{OUT} = 3 V_{PP}$ )**

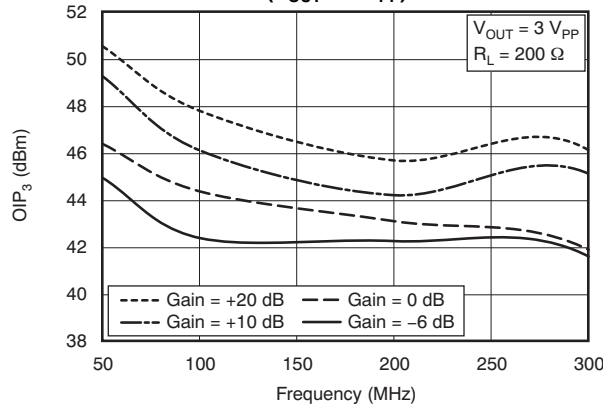
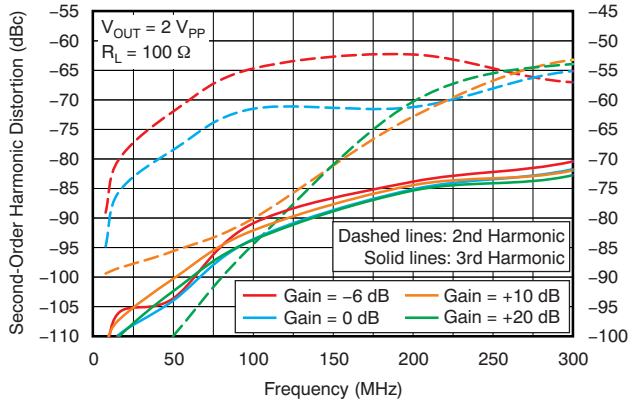

Figure 22.

**TYPICAL CHARACTERISTICS (continued)**

At  $T_A = +25^\circ\text{C}$ ,  $V_{S+} = +5\text{ V}$ , differential input signal, differential  $V_{OUT} = 2 V_{PP}$ ,  $R_L = 200\ \Omega$  differential,  $G = +20\text{ dB}$ , and input and output common-mode at internal midsupply reference, unless otherwise noted.

**HARMONIC DISTORTION vs FREQUENCY**  
( $V_{OUT} = 2 V_{PP}$ )



**Figure 23.**

**HARMONIC DISTORTION vs FREQUENCY**  
( $V_{OUT} = 2 V_{PP}$ )

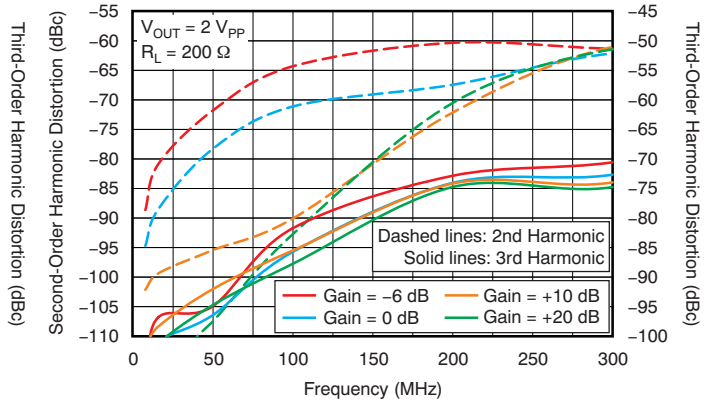

**Figure 24.**

**HARMONIC DISTORTION vs FREQUENCY**  
( $V_{OUT} = 2 V_{PP}$ )

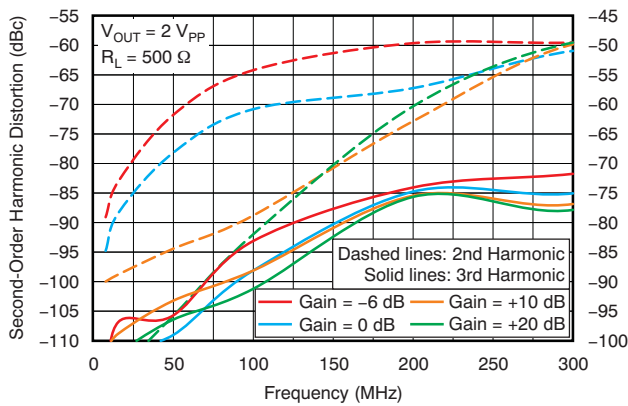

**Figure 25.**

**HARMONIC DISTORTION vs FREQUENCY**  
( $V_{OUT} = 2 V_{PP}$ )

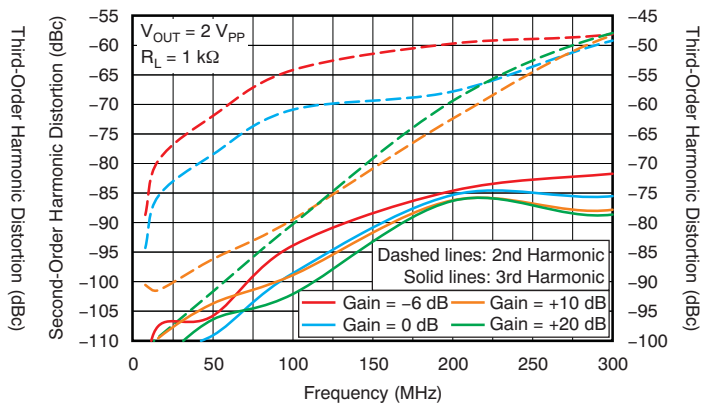

**Figure 26.**

**TYPICAL CHARACTERISTICS (continued)**

At  $T_A = +25^\circ\text{C}$ ,  $V_{S+} = +5\text{ V}$ , differential input signal, differential  $V_{OUT} = 2\text{ V}_{PP}$ ,  $R_L = 200\ \Omega$  differential,  $G = +20\text{ dB}$ , and input and output common-mode at internal midsupply reference, unless otherwise noted.

**HARMONIC DISTORTION vs FREQUENCY**  
( $V_{OUT} = 3\text{ V}_{PP}$ )

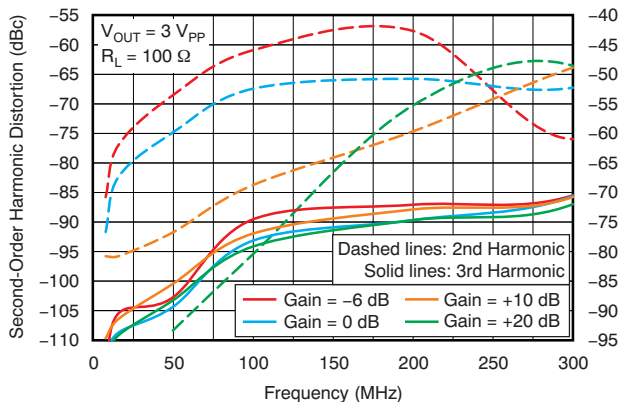

Figure 27.

**HARMONIC DISTORTION vs FREQUENCY**  
( $V_{OUT} = 3\text{ V}_{PP}$ )

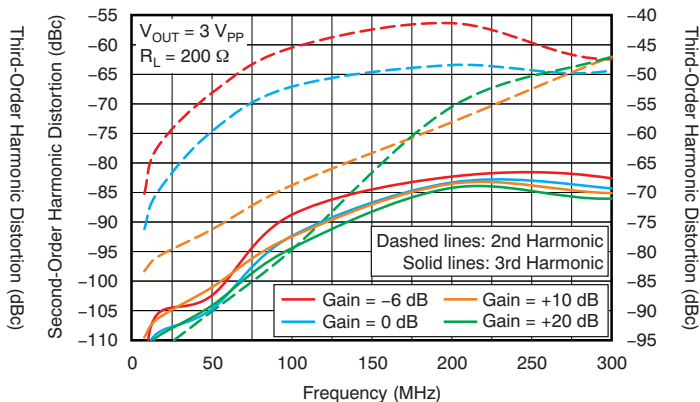

Figure 28.

**HARMONIC DISTORTION vs FREQUENCY**  
( $V_{OUT} = 3\text{ V}_{PP}$ )

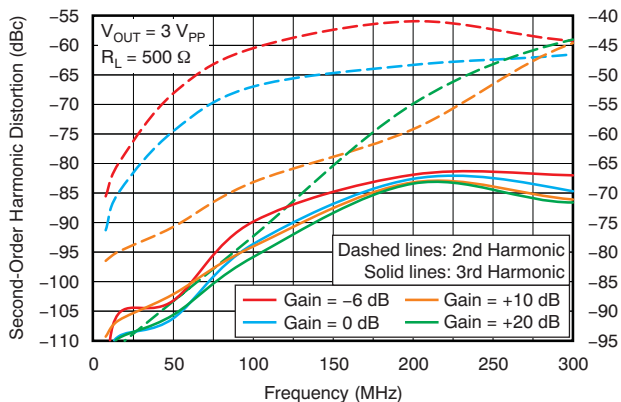

Figure 29.

**HARMONIC DISTORTION vs FREQUENCY**  
( $V_{OUT} = 3\text{ V}_{PP}$ )

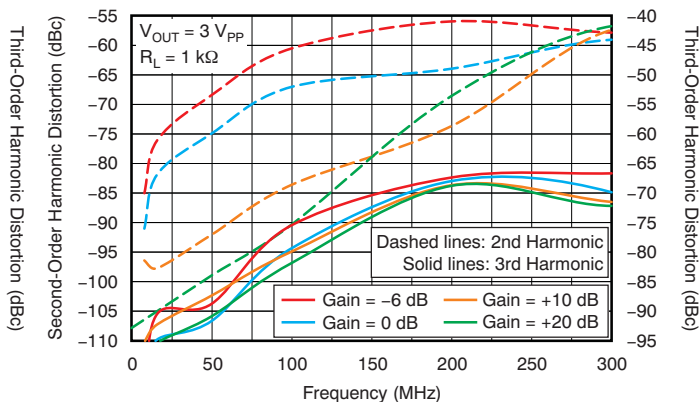

Figure 30.

**TYPICAL CHARACTERISTICS (continued)**

At  $T_A = +25^\circ\text{C}$ ,  $V_{S+} = +5\text{ V}$ , differential input signal, differential  $V_{OUT} = 2 V_{PP}$ ,  $R_L = 200\ \Omega$  differential,  $G = +20\text{ dB}$ , and input and output common-mode at internal midsupply reference, unless otherwise noted.

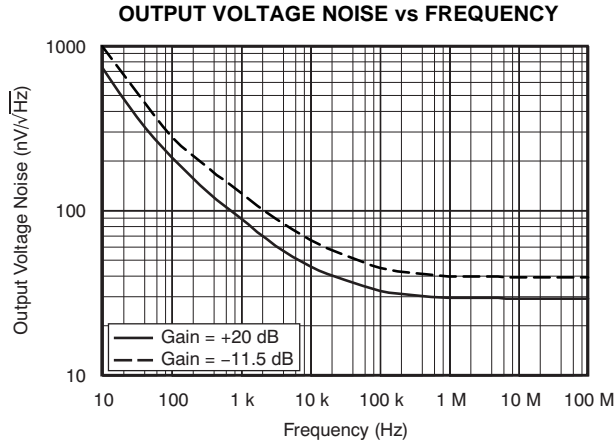

Figure 31.

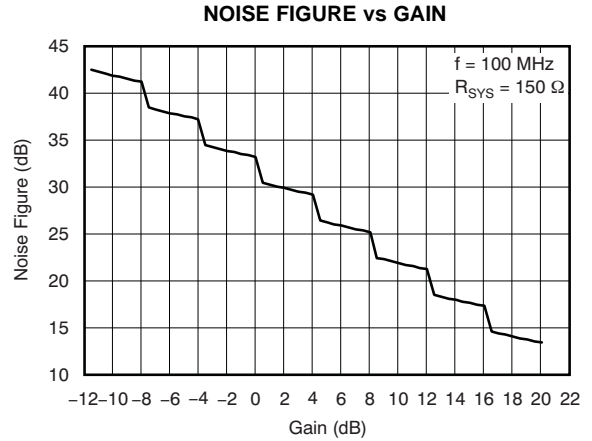

Figure 32.

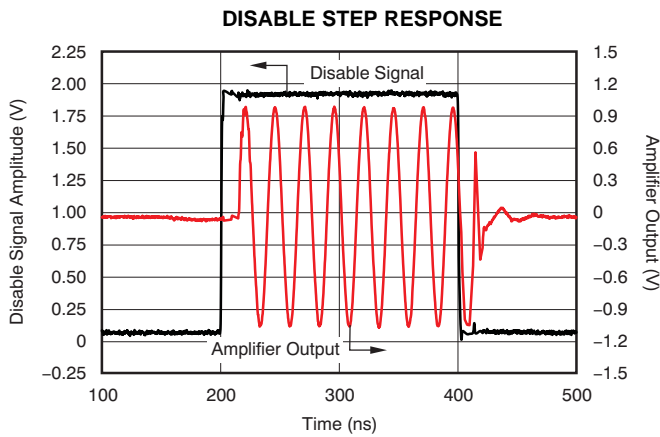

Figure 33.

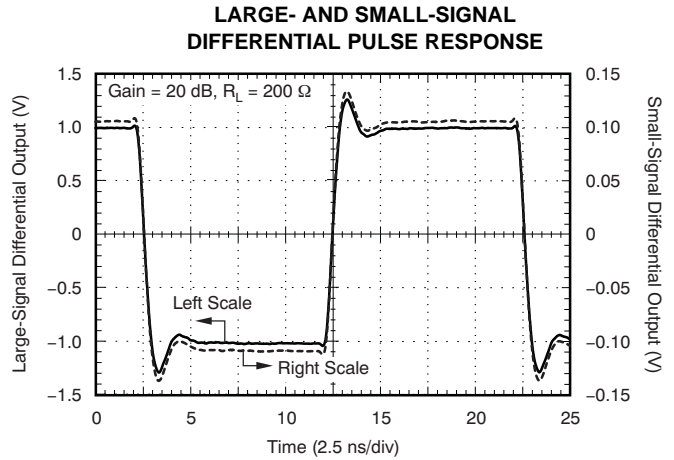

Figure 34.

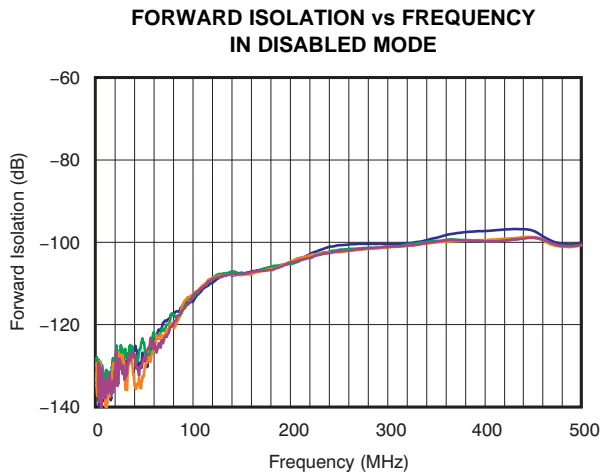

Figure 35.

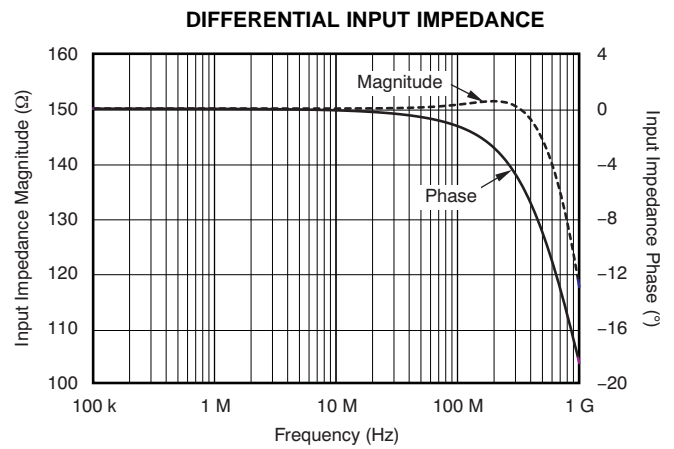

Figure 36.

**TYPICAL CHARACTERISTICS (continued)**

At  $T_A = +25^\circ\text{C}$ ,  $V_{S+} = +5\text{ V}$ , differential input signal, differential  $V_{OUT} = 2 V_{PP}$ ,  $R_L = 200\ \Omega$  differential,  $G = +20\text{ dB}$ , and input and output common-mode at internal midsupply reference, unless otherwise noted.

**DIFFERENTIAL INPUT RETURN LOSS vs FREQUENCY**

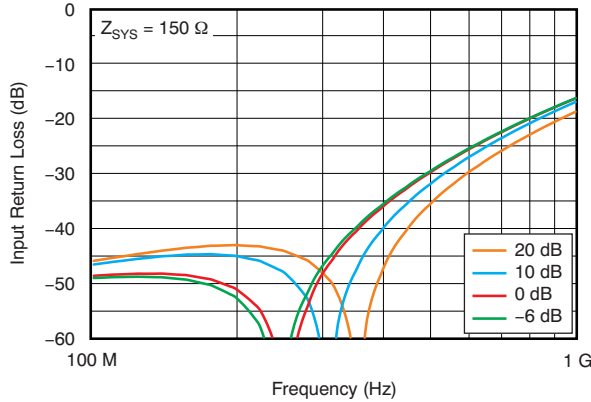

Figure 37.

**SINGLE-ENDED INPUT RETURN LOSS vs FREQUENCY**

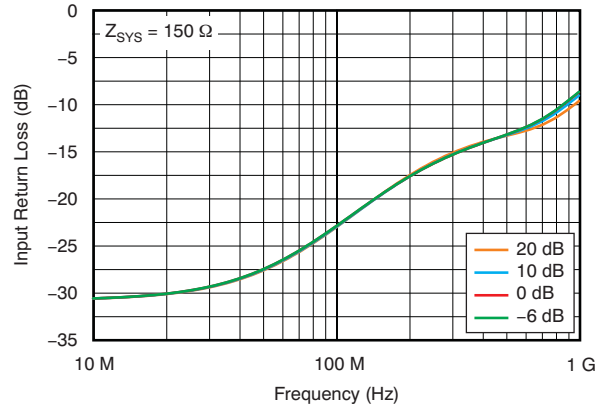

Figure 38.

**DIFFERENTIAL OUTPUT IMPEDANCE**

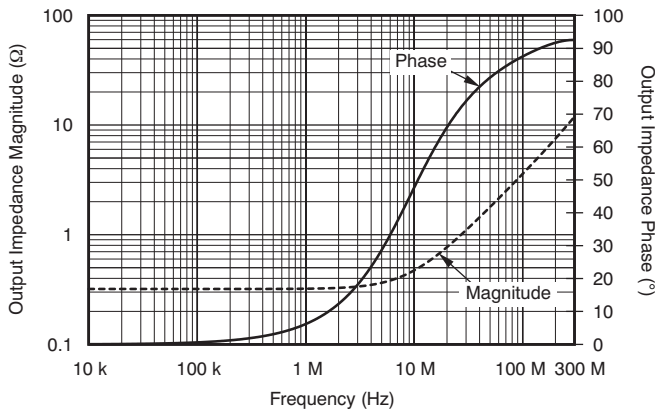

Figure 39.

**DIFFERENTIAL OUTPUT SWING vs R\_LOAD**

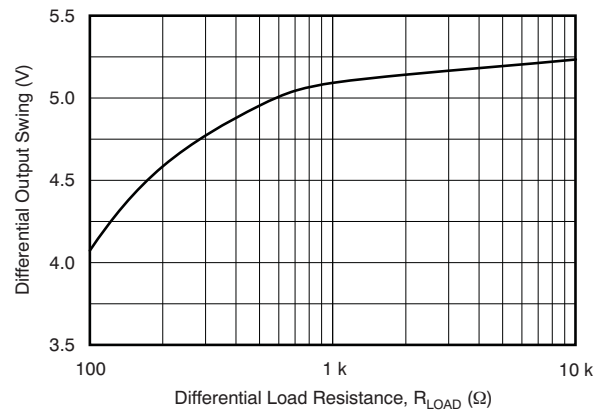

Figure 40.

**PSRR AND CMRR vs FREQUENCY**

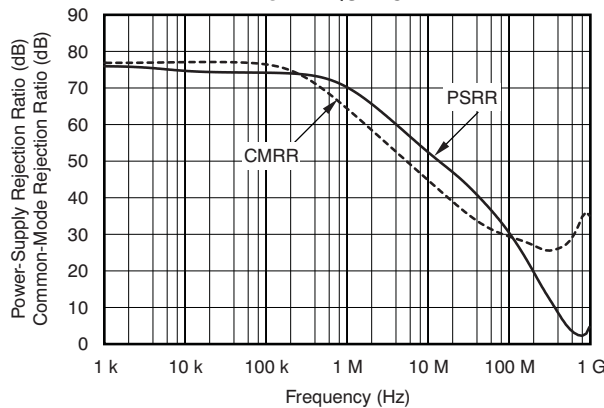

Figure 41.

## APPLICATION INFORMATION

### Device Operation

The PGA870 is a wideband, fully differential, programmable-gain amplifier. Looking at the block diagram in [Figure 42](#), the PGA870 can be separated into the following functional blocks:

- Input Attenuator
- Buffered MUX
- Output Amplifier
- 8-bit digital interface
- Power function

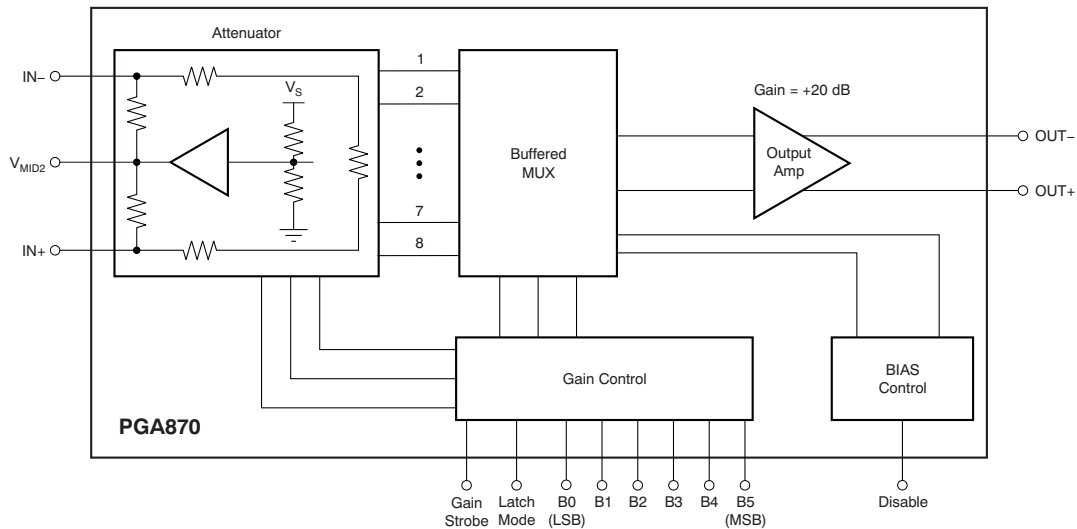

**Figure 42. PGA870 Block Diagram**

### Input Attenuator

The input stage of the PGA870 consists of a logarithmic R2R ladder and presents a 150-Ω load to the previous stage. To minimize input return loss and noise figure, it is recommended to provide a 150-Ω matching for that input. This input can be driven either differentially or single-ended.

This resistive input network is internally biased to midsupply by an internal buffer ( $V_{MID2}$  on pin 4). Proper bypassing is required on this node (0.1 μF). The buffer midsupply is generated by a passive resistor network ( $V_{MID1}$  on pin 28). A 0.1-μF capacitor is expected on  $V_{MID1}$  for adequate bypassing. Although  $V_{MID1}$  and  $V_{MID2}$  are externally accessible, neither of these pins is intended to be externally driven. Additionally,  $V_{MID2}$  is not intended to drive the midsupply reference to another chip, but can source approximately 200 μA if required.

During power-down operation, the input maintains its nominal differential resistance. However,  $V_{MD1}$  and  $V_{MID2}$  fall to 0 V. The input attenuator is controlled via the three most significant bits (MSBs) of the gain control. Refer to [Table 1](#) for the step size of each of these three MSBs.

### Input Amplifier and Buffered MUX

Following the input attenuator is a programmable buffer stage; the gain of the programmable buffer is controlled by the three least significant bits (LSBs) of the gain-control word. Refer to [Table 1](#) for the step size of each of these three LSBs.

**Table 1. Gain Bits and Corresponding Gain Step Sizes (in dB)**

(MSB) B5	B4	B3	B2	B1	(LSB) B0
16	8	4	2	1	0.5

## Output Amplifier

The PGA870 has a differential, voltage-mode output stage with a differential output resistance of approximately  $0.3\ \Omega$  and an inductive reactance equivalent to  $3.8\ \text{nH}$ . The common-mode output voltage has a nominal value of  $V_{\text{MID2}}$ . This output amplifier has a nominal gain of  $+20\ \text{dB}$ .

The nominal load is  $200\ \Omega$ , but the PGA870 can drive loads as low as  $100\ \Omega$  with only minor changes to the device distortion.

The output pins go to a high-impedance state when the device is the power-down state (that is, when  $\overline{\text{PD}}$  is low).

## 8-bit Digital Interface

The 8-bit digital interface is composed of six bits: three MSBs that control the input attenuation and three LSBs that control the input amplifier and buffered MUX. For more information on this parallel interface, refer to the [Gain Control and Latch Modes](#) section.

## Power Function

The PGA870 features a low-power disabled state for the analog circuitry when the power-down ( $\overline{\text{PD}}$ ) pin is low. In the disabled state, the digital circuitry remains active, which allows the gain to be set before device power-up. There is no internal circuitry to provide a nominal bias to this pin. If this pin is to be left open, it must be biased with an external pull-up resistor.

Note that when the PGA870 is in this low-power mode, the gain can be programmed using the 8-bit digital interface, the output pins go to a high-impedance state, and the voltage on the midsupply pins biasing the attenuator (pin 4 and pin 28) goes to  $0\ \text{V}$ .

## Gain Control and Latch Modes

The PGA870 has six bits of gain control (B5 to B0) that give an extended gain range from a maximum gain of  $20\ \text{dB}$  to a minimum gain of  $-11.5\ \text{dB}$ . The LSB (B0) represents a minimum gain change (step size) of  $0.5\ \text{dB}$ , and the LSB (B5) represents a gain change of  $16\ \text{dB}$ . The equivalent gain step size of each gain control bit is shown in [Table 1](#). The device voltage gain can be expressed by [Equation 1](#):

$$\text{Gain}_{\text{dB}} = 20\ \text{dB} - 0.5\ \text{dB} \times (N_G - 63) \quad (1)$$

$N_G$  is the equivalent base-10 integer number that corresponds to the binary gain control word. A summary of the 63 possible device gains versus  $N_G$  and the values of B0 to B5 are shown in [Table 2](#).

The high and low voltage thresholds allow all of the gain control pins to be controlled by CMOS circuitry. There are no internal pull-up resistors on the gain-control pins. If the pins are to be left open, they must be biased with external pull-up resistors.

The PGA870 can be configured so the device gain is controlled by only the six gain bits (*no latch*) when the GAIN STROBE pin and the GAIN MODE pin are both held high. In this operating mode, the device voltage gain follows the signals on pins B0 to B5. Transients on the six gain bits can cause changes to the PGA870 gain while in this mode, as well. To combat this possibility, the PGA870 also supports two gain modes where the gain bit data are acquired and latched by signals on the GAIN STROBE pin.

The device is configured for a *level-triggered latch* when the LATCH MODE pin is high; this configuration allows the six gain bits to be acquired and latched only on a high signal on the GAIN STROBE. When the GAIN STROBE signal goes low, the gain-control data are latched and the PGA870 gain is independent of the six gain bits until the GAIN STROBE goes high again.

If the PGA870 LATCH MODE pin is low, the device is configured for an *edge-triggered latch* that acquires and latches the six gain-control bits only on the falling edge of the GAIN STROBE signal.

**Table 2. PGA870 Gain and Corresponding Gain Word Values**

Gain State NG	Gain (dB)	(MSB) B5	B4	B3	B2	B1	(LSB) B0	Gain State NG	Gain (dB)	(MSB) B5	B4	B3	B2	B1	(LSB) B0
63	20	1	1	1	1	1	1	31	4	0	1	1	1	1	1
62	19.5	1	1	1	1	1	0	30	3.5	0	1	1	1	1	0
61	19	1	1	1	1	0	1	29	3	0	1	1	1	0	1
60	18.5	1	1	1	1	0	0	28	2.5	0	1	1	1	0	0
59	18	1	1	1	0	1	1	27	2	0	1	1	0	1	1
58	17.5	1	1	1	0	1	0	26	1.5	0	1	1	0	1	0
57	17	1	1	1	0	0	1	25	1	0	1	1	0	0	1
56	16.5	1	1	1	0	0	0	24	0.5	0	1	1	0	0	0
55	16	1	1	0	1	1	1	23	0	0	1	0	1	1	1
54	15.5	1	1	0	1	1	0	22	-0.5	0	1	0	1	1	0
53	15	1	1	0	1	0	1	21	-1	0	1	0	1	0	1
52	14.5	1	1	0	1	0	0	20	-1.5	0	1	0	1	0	0
51	14	1	1	0	0	1	1	19	-2	0	1	0	0	1	1
50	13.5	1	1	0	0	1	0	18	-2.5	0	1	0	0	1	0
49	13	1	1	0	0	0	1	17	-3	0	1	0	0	0	1
48	12.5	1	1	0	0	0	0	16	-3.5	0	1	0	0	0	0
47	12	1	0	1	1	1	1	15	-4	0	0	1	1	1	1
46	11.5	1	0	1	1	1	0	14	-4.5	0	0	1	1	1	0
45	11	1	0	1	1	0	1	13	-5	0	0	1	1	0	1
44	10.5	1	0	1	1	0	0	12	-5.5	0	0	1	1	0	0
43	10	1	0	1	0	1	1	11	-6	0	0	1	0	1	1
42	9.5	1	0	1	0	1	0	10	-6.5	0	0	1	0	1	0
41	9	1	0	1	0	0	1	9	-7	0	0	1	0	0	1
40	8.5	1	0	1	0	0	0	8	-7.5	0	0	1	0	0	0
39	8	1	0	0	1	1	1	7	-8	0	0	0	1	1	1
38	7.5	1	0	0	1	1	0	6	-8.5	0	0	0	1	1	0
37	7	1	0	0	1	0	1	5	-9	0	0	0	1	0	1
36	6.5	1	0	0	1	0	0	4	-9.5	0	0	0	1	0	0
35	6	1	0	0	0	1	1	3	-10	0	0	0	0	1	1
34	5.5	1	0	0	0	1	0	2	-10.5	0	0	0	0	1	0
33	5	1	0	0	0	0	1	1	-11	0	0	0	0	0	1
32	4.5	1	0	0	0	0	0	0	-11.5	0	0	0	0	0	0

**Table 3. Gain Control Signals and Latch Modes**

Latch Mode	GAIN STROBE	LATCH MODE	CONDITION
Edge-triggered latch	Falling edge	Low	Device gain follows and latches gain control word (B0 to B5) only on GAIN STROBE falling edge.
Level-triggered latch	Low	High	Device gain follows gain control word (B0 to B5) when GAIN STROBE and LATCH MODE are both high. Device gain latches when GAIN STROBE goes low.
No latch	High	High	Device gain is level-triggered on the gain-control word (B0 to B5) when LATCH MODE is high and GAIN STROBE remains high.

Table 3 and Figure 43 show a summary table and timing diagrams of the gain modes, respectively. Figure 44 illustrates a timing diagram that defines the transitions and timing of the set-up and hold times for both level-triggered and edge-triggered latch modes.

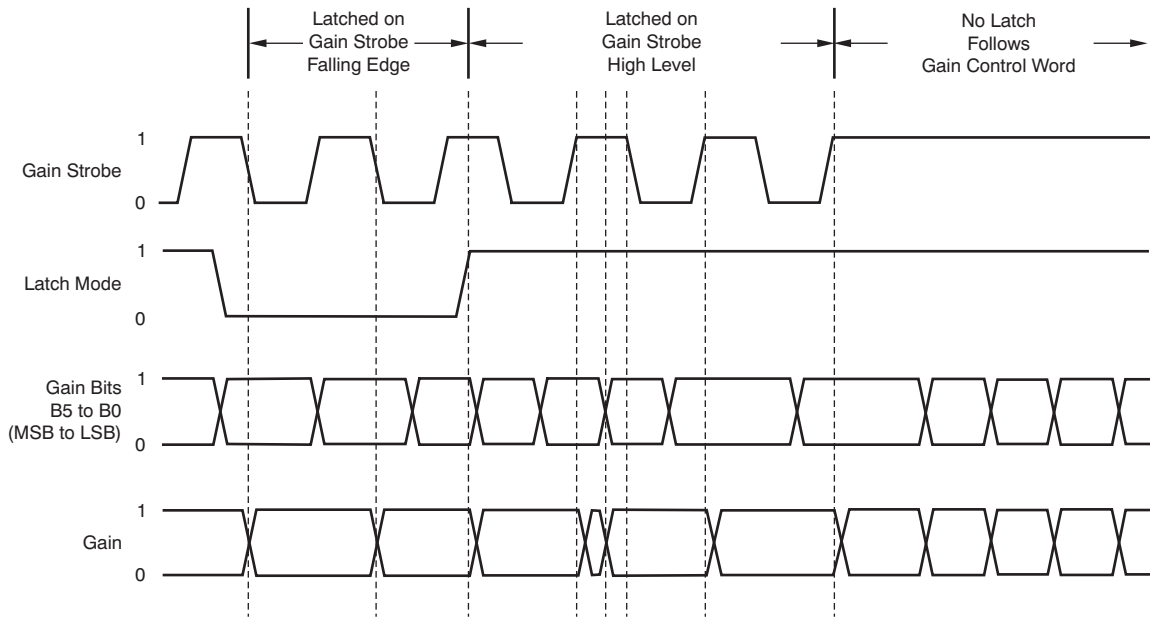

Figure 43. Gain Mode Timing

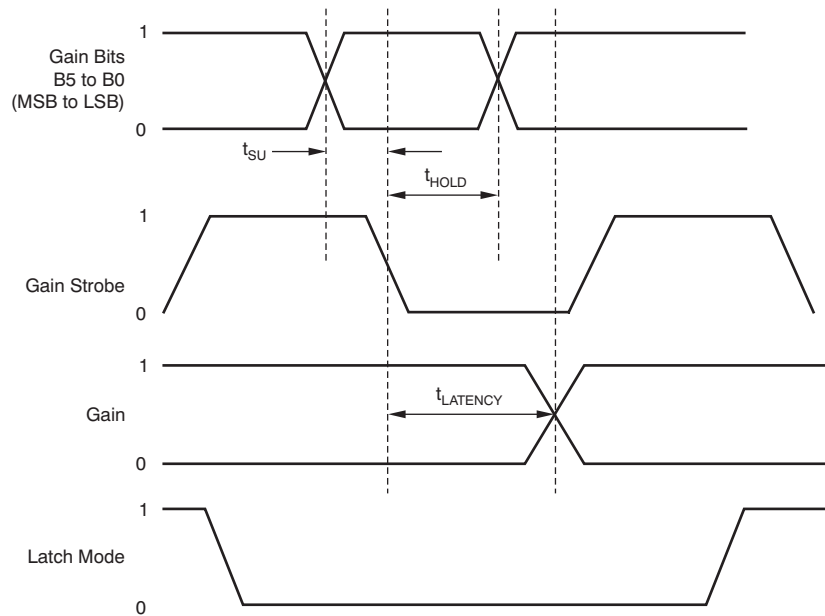
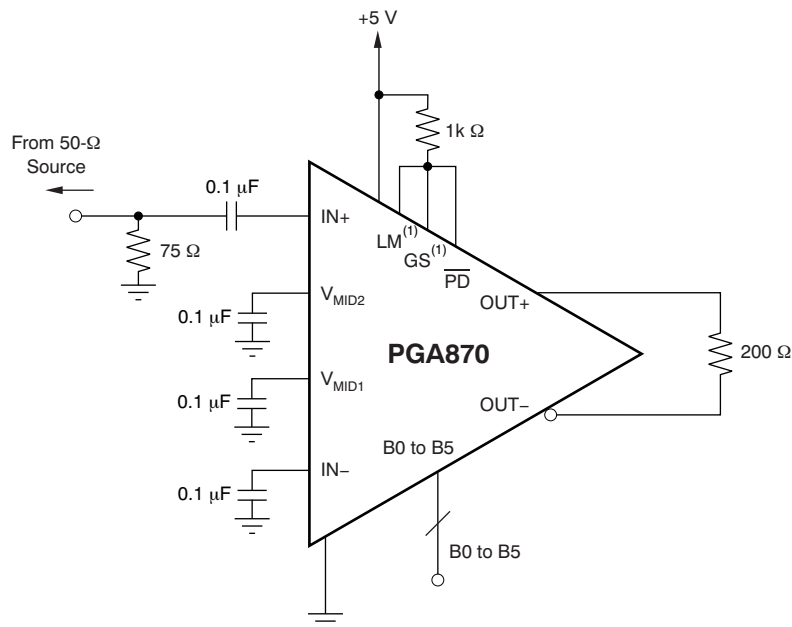

Figure 44. Set-Up and Hold Times: Level-Triggered and Edge-Triggered Latch Modes

## Single-Ended to Differential Operation

Figure 45 represents a single-ended to differential conversion test configuration with a 50-Ω source and a 200-Ω load. The midsupply pins  $V_{MID1}$  and  $V_{MID2}$  are properly bypassed; because this circuit is ac-coupled, these pins provide the biasing voltage required by the PGA870 input stage. The LATCH MODE, GAIN STROBE, and PD pins are connected to the supply voltage through a pull-up resistor. The PD pin set high powers up the PGA870, while setting the LATCH MODE and GAIN STROBE pins high bypasses the latch mode, allowing instantaneous gain changes as B5 to B0 change. On the noninverting input, a 75-Ω resistance was added to adapt the 150 Ω to 50 Ω and match the 50-Ω source.

If a single-ended signal source is to be dc-coupled to the device, its voltage swing should be centered about the midsupply reference,  $V_{MID1}$ . If the input dc voltage is greater than 0.2 V from midsupply, then increased distortion and reduced performance can result. The non-driven input pin of the PGA870 should be ac-coupled to ground through a capacitor. In this configuration, the PGA870 amplifies the difference between the dc-coupled input signal and the midsupply reference.



(1) LM = LATCH MODE pin (pin 1), GS = GAIN STROBE pin (pin 7).

**Figure 45. Basic Connections for Single-Ended to Differential Conversion**

## Differential-to-Differential Operation

Differential operation of PGA870 is shown in Figure 46. In this example, both input pins are connected to a differential 150- $\Omega$  source. The PGA870 is driving a typical 200- $\Omega$  load. Both midsupply voltage pins  $V_{MID1}$  and  $V_{MID2}$  are bypassed with a 0.1- $\mu$ F capacitor. The LATCH MODE, GAIN STROBE, and PD pins are connected to the power supply using a 1-k $\Omega$  pull-up resistor. The PD pin set high powers up the PGA870, while setting the Latch Mode and the Gain Strobe pins high bypasses the latch mode, allowing instantaneous gain changes as B5 to B0 change.

If a differential signal source is to be dc-coupled to the device, it should have a common-mode voltage that is within 0.2 V of the midsupply reference. If the input common-mode is greater than 0.2 V from midsupply, then increased distortion and reduced performance can result.

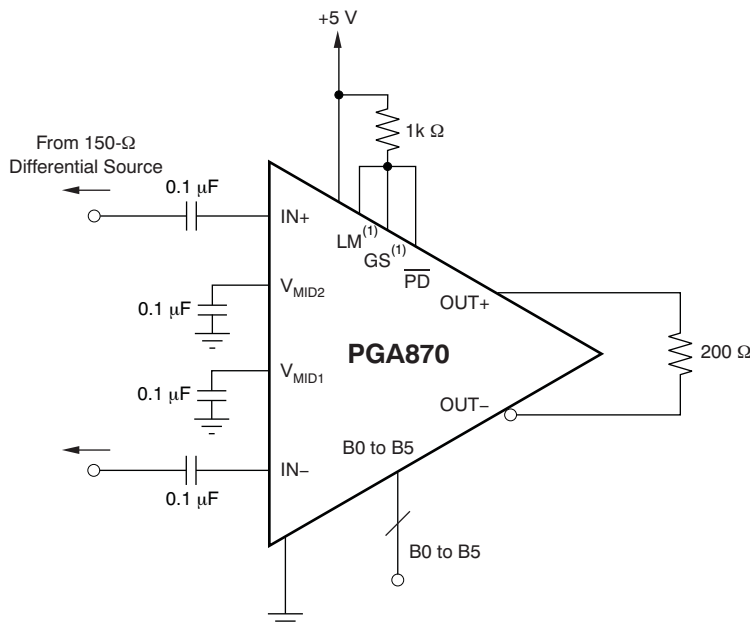

(1) LM = LATCH MODE pin (pin 1), GS = GAIN STROBE pin (pin 7).

**Figure 46. Basic Connections for Fully Differential Operation**

## Operation with Split Supply $\pm 2.5$ V

The PGA870 can be operated using a split  $\pm 2.5$ -V supply. In this case,  $V_{S+}$  is connected to +2.5 V, and GND (and any other pin noted to be connected to GND) is connected to  $-2.5$  V. As with any device, what the user decides to name the levels in the system is irrelevant to the PGA870. In essence, it is simply a level shift of the power pins and all voltage levels by  $-2.5$  V. With a  $\pm 2.5$ -V power supply, the output common-mode voltage is 0 V and input and output voltage ranges are symmetrical around 0 V. The power-down and gain control logic input thresholds all shift to relative to  $-2.5$  V; that is, the logic low threshold of 0.9 V with a single 5-V supply shifts to 1.6 V with  $\pm 2.5$ -V supplies, and the logic high threshold of 2.1 V with a single 5-V supply shifts to  $-0.4$  V with  $\pm 2.5$ -V supplies. Level-shifting the logic signals may require a comparator circuit for each logic signal line.

Figure 47 shows one possible circuit using one channel of the high-speed, 4.5-ns propagation delay TLV3502. The switching speed of the output logic signal is limited by the propagation delay of the comparator. Using slower comparators limits the digital logic speed and can thus limit the gain control speed in automatic gain control applications.

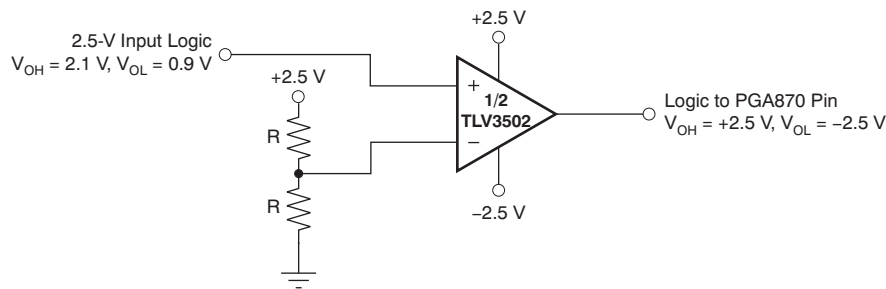
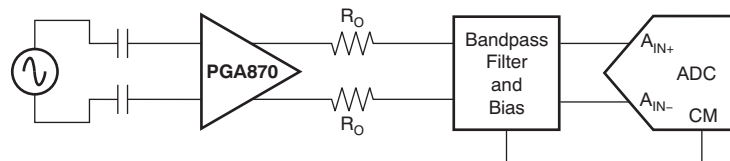

**Figure 47. Comparator Circuit to Shift Logic Signals to PGA870 Operated on Split ±2.5-V Supplies**

Using the PGA870 with split ±2.5-V supplies allows for an input signal centered around ground and sets the output common mode of the PGA870 to ground. The [ADC Input Common-Mode Voltage Considerations: DC-Coupled Input](#) section discusses how an output common-mode voltage of 0 V provides less signal attenuation when using a level-translating resistor network to drive an ADC with a low input common-mode voltage in dc-coupled applications.

## Driving ADCs

The PGA870 is designed and optimized to drive differential input ADCs for the lowest distortion performance. Figure 48 shows a generic block diagram of the PGA870 driving an ADC. The primary interface circuit between the amplifier and the ADC is a noise-limiting and anti-aliasing filter that may also provide a means to bias the signal to the input common-mode voltage required by the ADC. Filters range from single-order real RC poles to higher-order LC filters, depending on the application requirements. Output resistors ( $R_O$ ) are shown on the amplifier outputs to isolate the amplifier from any capacitive loading presented by the filter as the PGA870 presents a low impedance on its outputs.



**Figure 48. Generic ADC Driver Block Diagram**

Key points to consider for successfully implementing the PGA870 are described in the following subsections.

## SNR Considerations

Depending on the amplitude of the signal and the bandwidth of the filter, the SNR of the amplifier and filter together can be calculated. Note that the noise from the amplifier is band-limited by the filter with the equivalent brick-wall filter bandwidth. The amplifier and filter noise can be calculated using Equation 2.

$$\text{SNR}_{\text{Amp+Filter}} = 10 \log \left( \frac{V_o^2}{e_{\text{Filterout}}^2} \right) = 20 \log \left( \frac{V_o}{e_{\text{Filterout}}} \right)$$

with:

$$e_{\text{Filterout}} = e_{\text{NAmpout}} \sqrt{\text{ENB}} \quad (2)$$

$e_{NAmpout}$  is the output noise density of the PGA870 (30 nV/√Hz), ENB is the brick-wall equivalent noise bandwidth of the filter, and  $V_O$  is the amplifier output signal. For example, with a first-order ( $N = 1$ ) bandpass or low-pass filter with 30-MHz cutoff, the ENB is  $1.57 \cdot f_{-3dB} = 1.57 \cdot 30 \text{ MHz} = 47.1 \text{ MHz}$ . For second-order ( $N = 2$ ) filters, the ENB is  $1.22 \cdot f_{-3dB}$ .

As the filter order increases, the ENB approaches  $f_{-3dB}$  (for  $N = 3$ ,  $ENB = 1.15 \cdot f_{-3dB}$ , and for  $N = 4$ ,  $ENB = 1.13 \cdot f_{-3dB}$ ). Both  $V_O$  and  $e_{Filterout}$  are in RMS voltages. For example, with a 2- $V_{PP}$  ( $0.707 \cdot V_{RMS}$ ) output signal and 30-MHz first-order filter, the SNR of the amplifier and filter is 70.7 dB with  $e_{Filterout} = 30 \text{ nV}/\sqrt{\text{Hz}} \cdot \sqrt{47.1 \text{ MHz}} = 206 \mu\text{V}_{RMS}$ .

The signal-to-noise ratio (SNR) of the amplifier, filter, and ADC add in RMS fashion as shown in [Equation 3](#) (SNR values in dB):

$$SNR_{System} = -20 \log \left( \sqrt{10^{\frac{-SNR_{Amp+Filter}}{10}} + 10^{\frac{-SNR_{ADC}}{10}}} \right) \quad (3)$$

Using this equation, one can see that if the SNR of the amplifier + filter equals the SNR of the ADC, the combined SNR is 3 dB lower (that is, worse). For minimal impact (less than 1 dB) on the ADC SNR, the SNR of the amplifier and filter together should be  $\geq 10$  dB better than the ADC SNR. The combined SNR calculated in this manner is accurate to within  $\pm 1$  dB of actual implementation.

### SFDR Considerations

The SFDR of the amplifier is usually set by second-order or third-order harmonic distortion for single-tone inputs, and by second-order or third-order intermodulation distortion for two-tone inputs. Harmonics and second-order intermodulation distortion can be filtered to some degree by the filter, but third-order intermodulation spurious cannot be filtered. The ADC generates the same distortion products as the amplifier; however, as a result of the sampling and clock feedthrough, additional spurs (not linearly related to the input signal) are also added.

When the spurs from the amplifier and filter together are known, each individual spur can be directly added to the same spur from the ADC as shown in [Equation 4](#) to estimate the combined spur (spur amplitudes in dBc):

$$HDX_{System} = -20 \log \left( 10^{\frac{-HDX_{Amp+Filter}}{20}} + 10^{\frac{-HDX_{ADC}}{20}} \right) \quad (4)$$

Note that [Equation 4](#) assumes the spurs are in phase, but generally provides a good estimate of the final combined distortion.

For example, if the spur of the amplifier + filter equals the spur of the ADC, the combined spur is 6 dB higher. To minimize the amplifier contribution (less than 1 dB) to the overall system distortion, it is important that the spur from the amplifier + filter be  $\sim 15$  dB better than the converter. The combined spur calculated in this manner is usually accurate to within  $\pm 6$  dB of actual implementation, but higher variations have been observed, especially in second-order harmonic performance as a result of phase shift in the filter.

The worst-case spur calculation above assumes that the amplifier/filter spur of interest is in phase with the corresponding spur in the ADC, such that the two spur amplitudes can be added linearly. There are two phase shift mechanisms that cause the measured distortion performance of the amplifier-ADC chain to deviate from the expected performance calculated using [Equation 4](#): common-mode phase shift and differential phase shift.

*Common-mode phase shift* is the phase shift seen equally in both branches of the differential signal path, including the filter. This common-mode phase shift nullifies the basic assumption that the amplifier/filter and ADC spur sources are in phase. This phase shift can lead to better performance than predicted as the spurs are phase shifted, and there is the potential for cancellation as the phase shift reaches  $180^\circ$ . However, there is a significant challenge when designing an amplifier-ADC interface circuit to take advantage of common-mode phase shift for cancellation: the phase characteristic of the ADC spur sources are unknown, and therefore the necessary phase shift in the filter and signal path for cancellation is unknown.

*Differential phase shift* is the difference in the phase response between the two branches of the differential filter signal path. Differential phase shift in the filter as a result of mismatched components caused by nominal tolerance can severely degrade the even-order distortion of the amplifier-ADC chain. This condition has the same effect as mismatched path lengths for the two differential traces, and causes more phase shift in one path than the other. Ideally, the phase response over frequency through the two sides of a differential signal path are identical, such that even-order harmonics remain optimally out of phase and cancel when the signal is taken differentially. However, if one side has more phase shift than the other, then the even-order harmonic cancellation is not as effective.

Single-order RC filters cause very little differential phase shift with nominal tolerances of 5% or less, but higher-order LC filters are very sensitive to component mismatch. For instance, a third-order Butterworth bandpass filter with 100-MHz center frequency and 20-MHz bandwidth shows up to 20° differential phase imbalance in a Spice Monte Carlo analysis with 2% component tolerances. Therefore, while a prototype may work, production variance is unacceptable. In ac-coupled applications that require second- and higher-order filters between the PGA870 and ADC, a transformer or balun is recommended at the ADC input to restore the phase balance. For dc-coupled applications where a transformer or balun at the ADC input cannot be used, it is recommended to use first- or second-order filters to minimize the effects of differential phase shift as a result of component tolerance.

### ADC Input Common-Mode Voltage Considerations: AC-Coupled Input

The input common-mode voltage range of the ADC must be respected for proper operation. In an ac-coupled application between the amplifier and the ADC, the input common-mode voltage bias of the ADC is accomplished in different ways depending on the specific ADC. Some ADCs use internal bias networks, and the analog inputs are automatically biased to the required input common-mode voltage if the inputs are ac-coupled with capacitors (or if the filter between the amplifier and ADC is a bandpass filter). Other ADCs supply the required input common-mode voltage as a reference voltage output at a CM pin. With these types of ADCs, the ac-coupled input signal can be re-biased to the input common-mode voltage by connecting resistors from each input to the CM output of the ADC, as shown in Figure 49. However, the signal is attenuated because of the voltage divider created by  $R_{CM}$  and  $R_O$ .

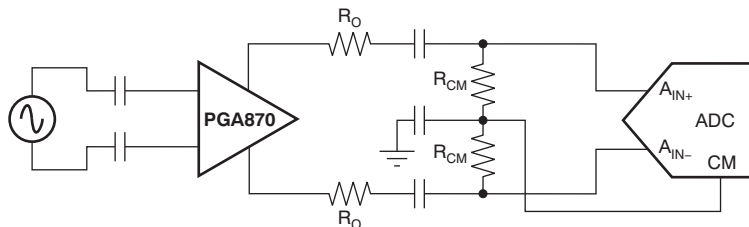

**Figure 49. Biasing AC-Coupled ADC Inputs with the ADC CM Output**

The signal can be re-biased when ac coupling, and therefore the output common-mode voltage of the amplifier is a *don't care* for the ADC.

### ADC Input Common-Mode Voltage Considerations: DC-Coupled Input

DC-coupled applications vary in complexity and requirements depending on the ADC; one requirement is the need to resolve the mismatch between the common-mode voltage of the driving amplifier and the ADC. For example, while the PGA870 has a fixed output common-mode of midsupply, or 2.5 V on a single 5-V supply, the ADS6149 requires a nominal 1.5-V input common-mode. The ADS58C48 and ADS4149, however, both require a nominal 0.95-V input common-mode. As Figure 50 shows, a resistor network can be used to perform a common-mode level shift. This resistor network consists of the amplifier series output resistors and pull-up or pull-down resistors to a reference voltage. This resistor network introduces signal attenuation that may prevent the use of the full-scale input range of the ADC. ADCs with an input common-mode closer to the PGA870 output common-mode of 2.5 V are easier to use in a dc-coupled configuration, and require little or no level shifting.

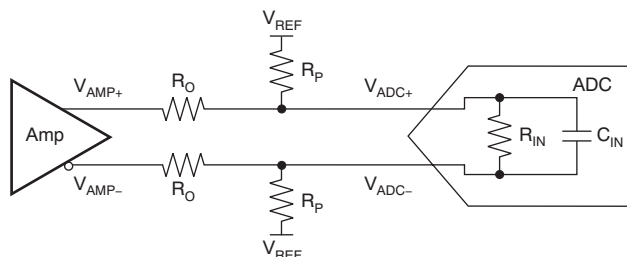

Figure 50. Resistor Network to DC Level-Shift Common-Mode Voltage

For common-mode analysis of the circuit in Figure 48, assume that  $V_{AMP\pm} = V_{OCM}$  (for the PGA870, 2.5 V on a single 5-V supply) and  $V_{ADC\pm} = V_{CM}$  (the specification for the ADC input common-mode voltage).  $V_{REF}$  is chosen to be a voltage within the system greater than  $V_{CM}$  (such as the ADC or amplifier analog supply) or ground, depending on whether the voltage must be pulled up or down, respectively, and  $R_O$  is chosen to be a reasonable value, such as 24.9  $\Omega$ . With these known values,  $R_P$  can be found by using Equation 5.

$$R_P = R_O \frac{V_{ADC} - V_{REF}}{V_{AMP} - V_{CM}} \quad (5)$$

Shifting the common-mode with the resistor network comes at the expense of signal attenuation. Modeling the ADC input as the parallel combination of a resistance  $R_{IN}$  and capacitance  $C_{IN}$  using values taken from the respective ADC data sheet, the approximate differential input impedance,  $Z_{IN}$ , for the ADC can be calculated at the signal frequency. This impedance creates a divider with the resistor network, whose gain (attenuation) can be calculated by Equation 6:

$$GAIN = \left( \frac{2R_P \parallel Z_{IN}}{2R_O + 2R_P \parallel Z_{IN}} \right) \quad (6)$$

The introduction of the  $R_P$  resistors also modifies the effective load seen by the amplifier. The effective load seen by the amplifier is then calculated by Equation 7.

$$R_L = 2R_O + 2R_P \parallel Z_{IN} \quad (7)$$

The  $R_P$  resistors act in parallel to the ADC input such that the effective load (that is, the output current) seen by the amplifier is increased. Higher current loads limit the PGA870 differential output swing and the typical distortion performance is only specified for load impedances of 100- $\Omega$  differential and greater.

Using the gain and knowing the full-scale input of the ADC,  $V_{ADC\_FS}$ , the required amplitude to drive the ADC with the network can be calculated with Equation 8.

$$V_{AMP\_PP} = \frac{V_{ADC\_FS}}{GAIN} \quad (8)$$

Using the ADC examples given previously, [Table 4](#) shows sample calculations of the value of  $R_P$  and  $V_{AMP\_FS}$  for full-scale drive, and then for  $-1$  dBFS.

**Table 4. Example  $R_P$  for Various ADCs**

ADC	$V_{AMP}$ ( $V_{DC}$ )	$V_{CM}$ ( $V_{DC}$ )	$V_{REF}$ ( $V_{DC}$ )	ADC $R_{IN} \parallel C_{IN}$ at 170 MHz ( $\Omega$ )	$R_O$ ( $\Omega$ )	$R_P$ ( $\Omega$ )	GAIN (V/V)	GAIN (dB)	$V_{ADC\_FS}$ ( $V_{PP}$ )	$V_{AMP\_PP}$ for 0 dBFS ( $V_{PP}$ )	$V_{AMP\_PP}$ -1 dBFS ( $V_{PP}$ )
ADS6149	2.5	1.5	0	216	25	37.5	0.53	-5.57	2	3.80	3.38
ADS58C48/ ADS4149	2.5	0.95	0	195	25	15.3	0.35	-9.21	2	5.78	5.15
ADS58C48/ ADS4149 <sup>(1)</sup>	0	0.95	2.5	195	25	40.8	0.53	-5.43	2	3.74	3.33

(1) PGA870 operated with  $\pm 2.5$ -V supply.

As [Table 4](#) shows, the signal attenuation as a result of the added resistor network increases as the required common-mode shift increases. For the ADS6149, the required common-mode level shift is  $-1$  V, from 2.5 V to 1.5 V, and the signal attenuates by 5.57 dB. This difference is a significant signal loss, and the amplifier output must be increased (either by increasing the PGA870 input or the PGA870 gain) to make up for the loss in order to drive the full-scale input of the ADC for the highest SNR. At the same time, increasing the amplifier output swing results in degraded distortion performance as the amplifier output approaches its output range limits.

For the ADS58C48/ADS4149 case with the PGA870 operated with a single 5-V supply, the required level shift is  $-1.55$  V and the signal attenuates by 9.21 dB. This signal loss cannot be fully recovered by increasing the PGA870 output: the differential output swing required at the PGA870 output to drive the full-scale range of the ADS58C48/ADS4149 exceeds the PGA870 output swing capability. Additionally, the distortion performance of the amplifier is degraded as the output swing increases. In these configurations, the maximum recommended ADC input is  $-6$  dBFS in order to limit the impact of the additional loading. Another option is to operate the PGA870 with a split  $\pm 2.5$ -V supply, with the resulting calculations shown in the last row of [Table 4](#). For this situation, if  $+2.5$  V is used as the  $V_{REF}$  pull-up voltage, the PGA870 only needs to drive  $3.33 V_{PP}$  at its output to drive the ADS58C48/ADS4149 input to  $-1$  dBFS. See the [Operation with Split Supply  \$\pm 2.5\$ V](#) section for more details on using the PGA870 with split supplies.

As with any design, testing is recommended to validate whether the result meets the specific design goals.

## PGA870 Driving ADS58C48

To illustrate the performance of the PGA870 as an ADC driver, the PGA870 is tested with the ADS58C48 and bandpass filter designs centered at an operating frequency of 170 MHz. The ADS58C48 is a quad-channel, 11-bit, 200-MSPS ADC with LVDS-compatible digital outputs on six data pairs per channel. The device has unbuffered analog inputs. There are several key information points to consider when interfacing to the PGA870:

- Unbuffered analog inputs with a frequency-dependent input impedance of  $Z_{IN} = R_{IN} \parallel C_{IN}$
- 0.95-V analog input common-mode voltage
- SNR = 66.1 dBFS (typ) at  $f_{IN} = 170$  MHz
- SFDR = 80 dBc (typ) at  $f_{IN} = 170$  MHz
- $HD_2 = 82$  dBc (typ) at  $f_{IN} = 170$  MHz
- $HD_3 = 80$  dBc (typ) at  $f_{IN} = 170$  MHz
- IMD = 83 dBFS (typ) with two-tone input  $f_{IN1} = 185$  MHz,  $f_{IN2} = 190$  MHz

The [ADS58C48EVM](#) is designed for flexible options to ease design work. Used in conjunction with the [TSW1200EVM High-Speed ADC LVDS Evaluation System](#), it reduces evaluation time to help the designer move from prototype to production more quickly.

The ADS58C48EVM provides back-to-back input transformers for each of the four analog input channels in order to convert single-ended test signals to differential when driving the ADCs directly. The Channel D path on the EVM, however, provides an alternate path (selectable via jumper resistors) for driving the channel with an onboard PGA870. In this path, a single-ended input test signal can be converted to differential with a single transformer to drive the PGA870 input. The EVM provides various component pads between the PGA870 and ADS58C48 input for implementing various filter types. For the latest schematic of the EVM, refer to the [ADS58C48EVM Design Package](#) available through the [ADS58C48EVM product page](#) on the TI website.

## Testing the PGA870 with a First-Order Bandpass Filter

Differential phase shift in a differential filter because of component mismatches can lead to severely degraded even-order distortion performance. In applications where good SFDR performance at the expense of slight degradation in SNR is acceptable, a first-order filter can prove to be less sensitive and provide more repeatable results compared to higher-order filters.

Figure 51 shows a simplified schematic of the PGA870 driving Channel D of the ADS58C48 on an ADS58C48EVM with a first-order bandpass filter designed for 50-MHz bandwidth at a center frequency of 170 MHz. As a result of board parasitics, the measured  $-3$ -dB bandwidth of the filter is 70 MHz. The measured  $-1$ -dB bandwidth of the filter is 40 MHz. At 20 dB of gain, the output voltage noise specification of the PGA870 is 30 nV/ $\sqrt{\text{Hz}}$ . With 2- $V_{PP}$  differential output swing and 70-MHz bandwidth, the expected SNR from the combined amplifier and filter is 68.7 dB. Added in combination with the ADS58C48 SNR, the expected SNR of the amplifier, filter, and ADC chain is 64 dBFS.

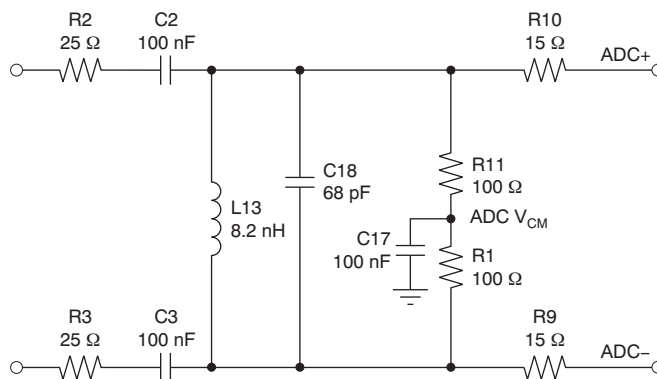

Figure 51. First-Order Bandpass Filter Schematic

Figure 52 shows the resulting FFT plot captured using the TSW1200 software with the PGA870 and first-order filter driving the ADS to  $-1$  dBFS, with a single-tone input 170-MHz sine wave sampled at 200 MSPS. The results show 81.7-dBc SFDR and 63.7-dBFS SNR; analysis of the plot is provided in Table 5. The PGA870 is set to a maximum gain of 20 dB. Figure 53 shows the FFT plot with the PGA870 set to a gain of  $-4$  dB, with the input signal amplitude increased accordingly to achieve  $-1$  dBFS at the ADC input. The results show 5 dB lower SFDR at this gain setting, which is expected at lower gains (see the *Harmonic Distortion vs Frequency* graphs, Figure 23 through Figure 30); however, the SNR remains the same at approximately 63.8 dBFS.

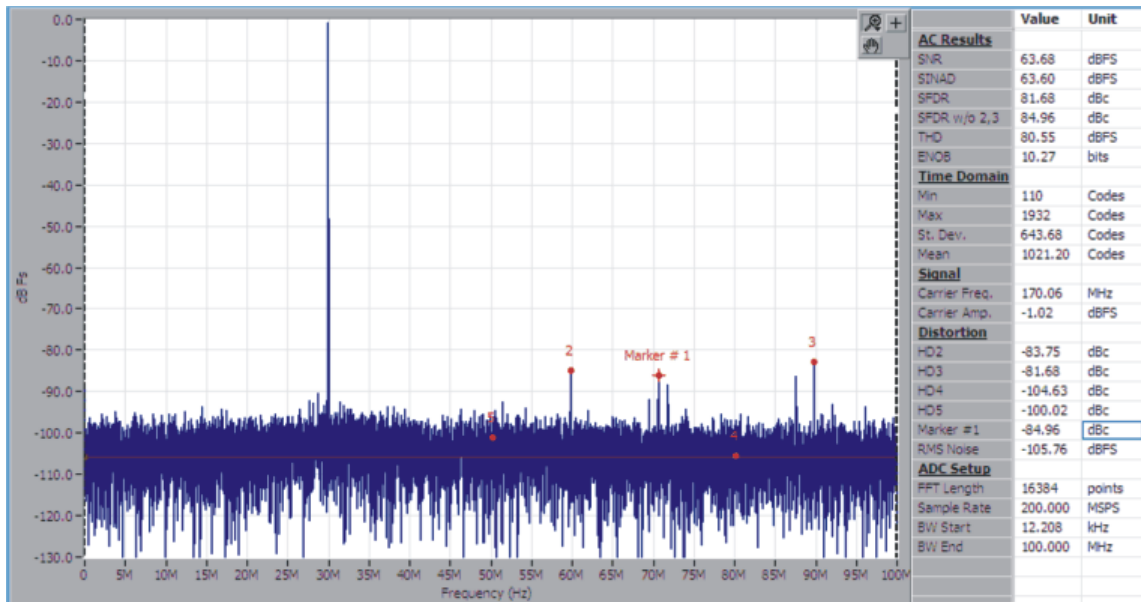

Figure 52. FFT Plot of PGA870 (G = 20 dB) + First-Order Bandpass Filter and ADS58C48 with Single-Tone Input at 170 MHz

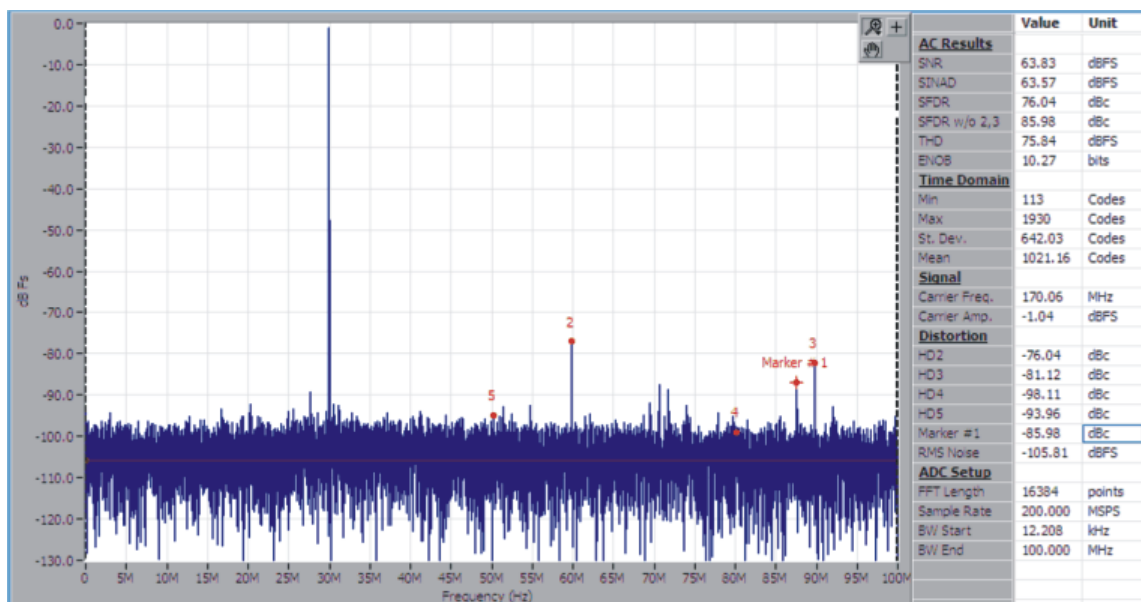

Figure 53. FFT Plot of PGA870 (G = -4 dB) + First-Order Bandpass Filter and ADS58C48 with Single-Tone Input at 170 MHz

Table 5. Analysis of FFT for PGA870 (G = 20 dB) + First-Order Bandpass Filter and ADS58C48 at 170 MHz vs Typical ADC Specifications

CONFIGURATION	ADC INPUT	SNR	HD <sub>2</sub>	HD <sub>3</sub>
PGA870 + First-order Bandpass Filter and ADS58C48	-1 dBFS	63.7 dBFS	-83.8 dBc	-81.7 dBc
ADS58C48 Only (typ)	-1 dBFS	66.1 dBFS	-82 dBc	-80 dBc

Figure 54 and Figure 55 each show the FFT plots for the same first-order bandpass filter circuit with two-tone inputs, with each tone at  $-7$  dBFS and the PGA870 set to a gain of 20 dB. Figure 54 shows the FFT for two-tone inputs at 160 MHz and 170 MHz. The third-order intermodulation distortion products at 150 MHz and 180 MHz are less than  $-86$  dBc. Figure 55 shows the FFT for two-tone inputs at 168 MHz and 170 MHz. The highest spur is the third-order intermodulation product at 172 MHz at  $-85$  dBFS.

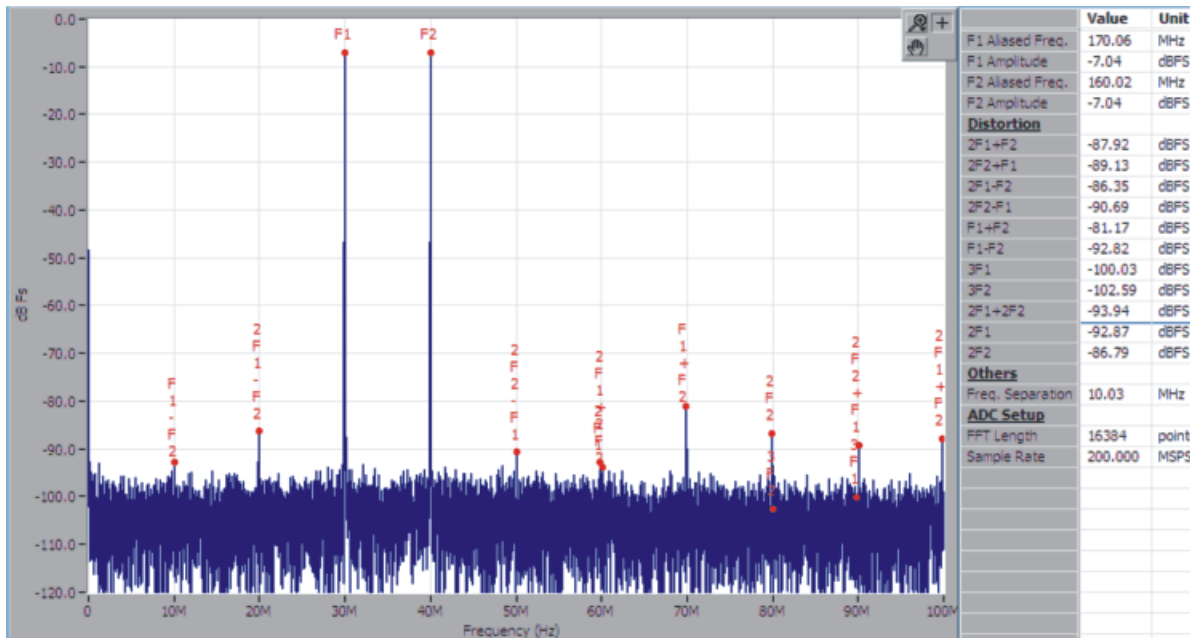

Figure 54. FFT Plot of PGA870 (G = 20 dB) + First-Order Bandpass Filter and ADS58C48 with Two-Tone Inputs at 160 MHz and 170 MHz

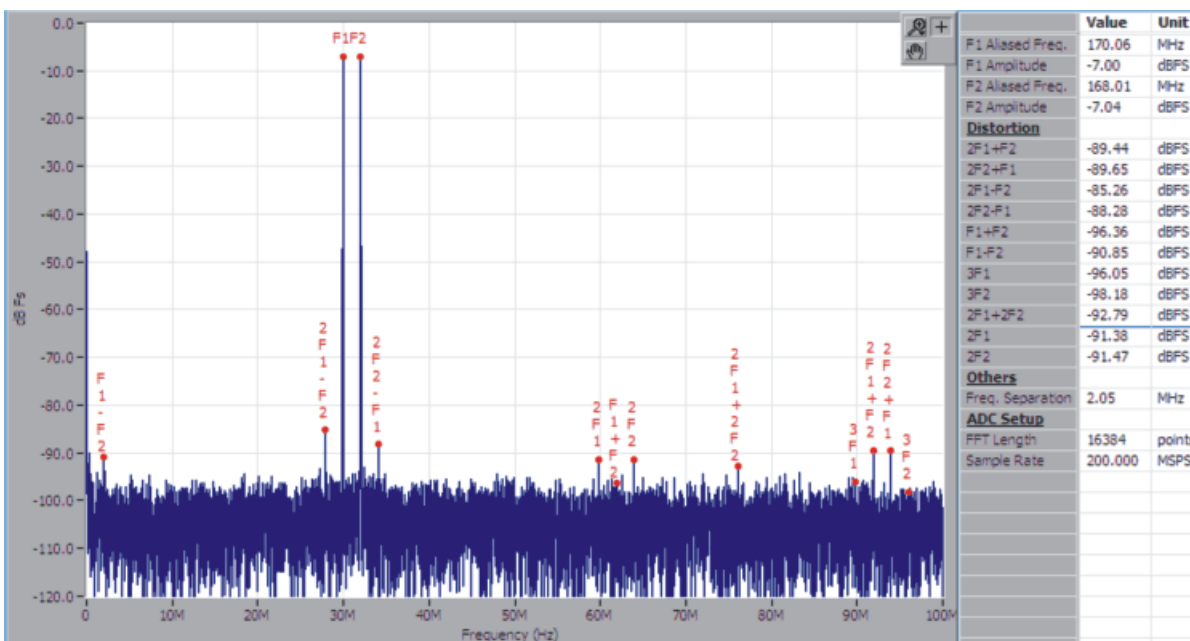
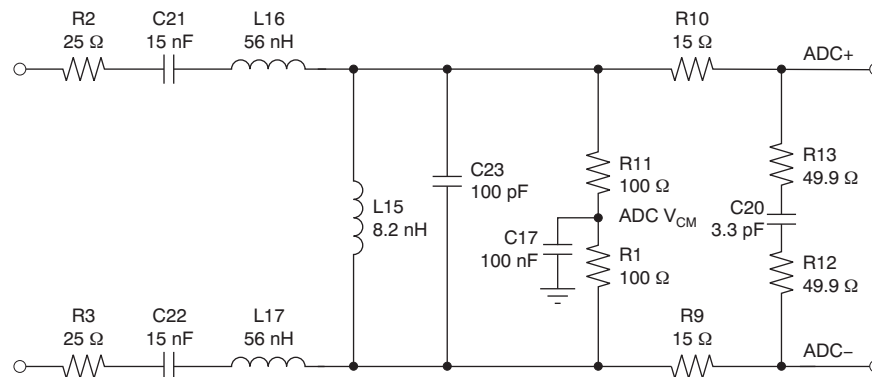

Figure 55. FFT Plot of PGA870 (G = 20 dB) + First-Order Bandpass Filter and ADS58C48 with Two-Tone Inputs at 168 MHz and 170 MHz

## Testing the PGA870 with a Second-Order Bandpass Filter

For better combined SNR performance, narrower bandwidth and/or higher-order filters are required between the PGA870 and ADC. However, narrow filter bandwidth and high-order filters cause the signal chain performance to depend more strongly on component tolerance and mismatch. Component values that are 5% off from nominal can detune a narrowband filter to the point that the desired signals do not fall within the useful passband and become attenuated. Mismatch between corresponding series components on the positive and negative sides of the differential filter can result in a differential phase shift that degrades even-order distortion performance. As mentioned in the [SFDR Considerations](#) section, a transformer or balun is recommended at the ADC input in these applications to restore the phase balance in the input signal to the ADC. The results shown in this discussion interface the PGA870 and filter directly to the ADS58C48 input, and other builds of the same filter on the same EVM showed over 10 dB of variation in distortion performance.

[Figure 56](#) shows a simplified schematic of the PGA870 driving Channel D of the ADS58C48 on an ADS58C48EVM with a second-order bandpass filter designed for 50-MHz bandwidth at a center frequency of 170 MHz. The measured  $-3$ -dB bandwidth of the filter is 57 MHz. The measured  $-1$ -dB bandwidth of the filter is 34 MHz. At a gain of 20 dB, the output voltage noise specification of the PGA870 is  $30 \text{ nV}/\sqrt{\text{Hz}}$ . With  $2\text{-}V_{\text{PP}}$  differential output swing and 57-MHz bandwidth, the expected SNR from the combined amplifier and filter is 70 dB. Added in combination with the typical ADS58C48 SNR, the expected SNR of the amplifier, filter, and ADC chain is 64.5 dBFS.



**Figure 56. Second-Order Bandpass Filter Schematic**

[Figure 57](#) shows the resulting FFT plot captured using the TSW1200 software with the PGA870 and a second-order filter driving the ADS to  $-1$  dBFS, with a single-tone input 170-MHz sine wave sampled at 200 MSPS. The results show 87.76-dBc SFDR and 65-dBFS SNR; analysis of the plot is shown in [Table 6](#). The PGA870 is set to a maximum gain of 20 dB. [Figure 58](#) shows the FFT plot with the PGA870 set instead to a gain of  $-4$  dB, with the input signal amplitude increased accordingly to obtain  $-1$  dBFS at the ADC input. The results show about 1 dB lower SFDR at this gain setting and no change in the SNR.

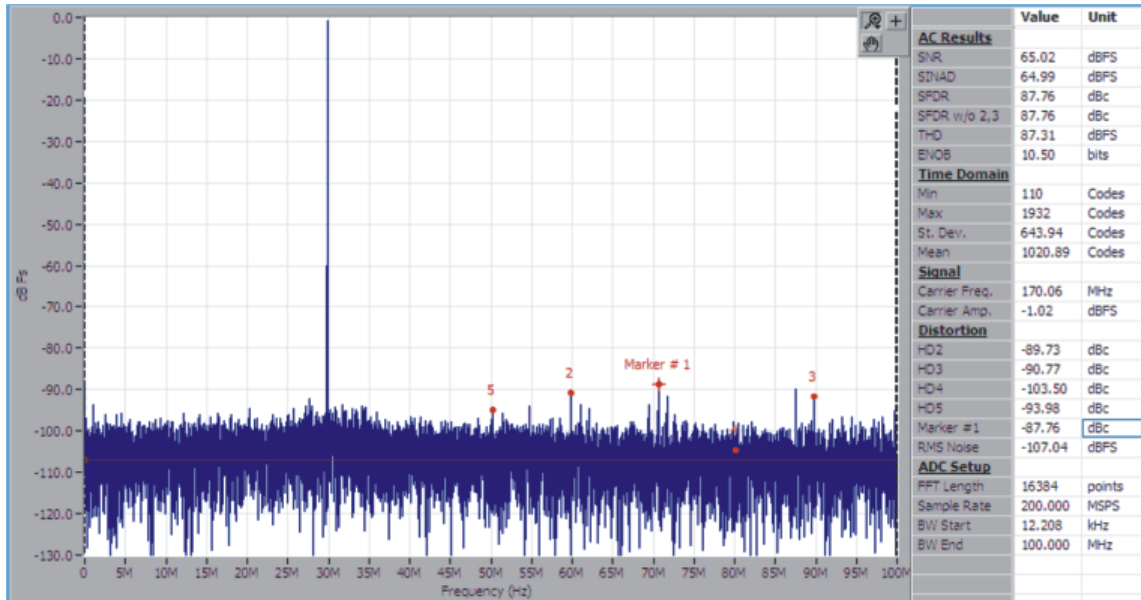

Figure 57. FFT Plot of PGA870 (G = 20 dB) + Second-Order Bandpass Filter and ADS58C48 with Single-Tone Input at 170 MHz

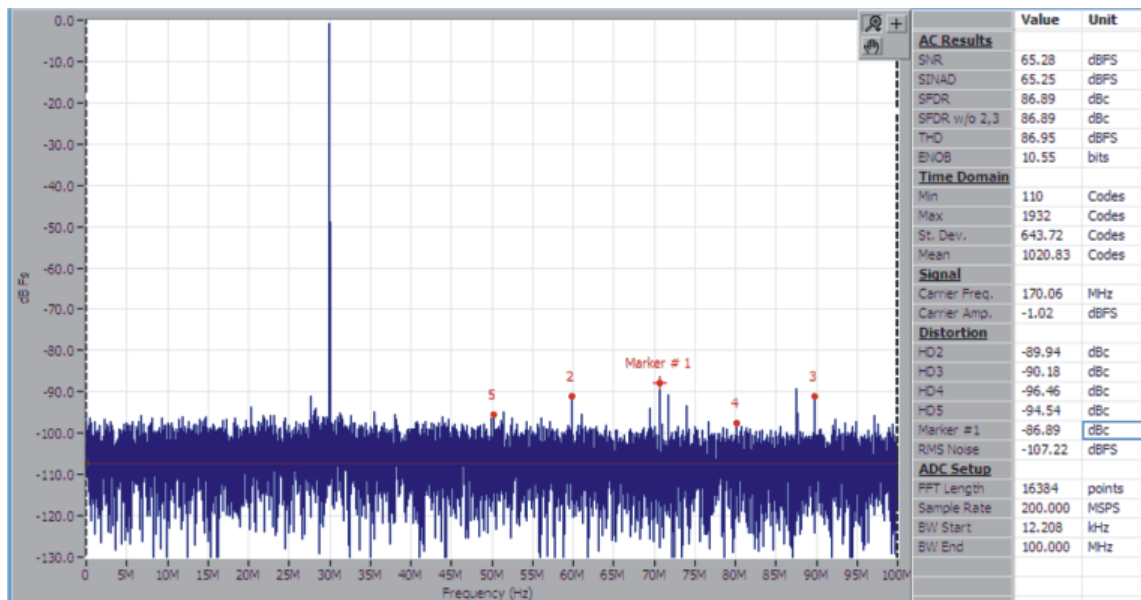

Figure 58. FFT Plot of PGA870 (G = -4 dB) + Second-Order Bandpass Filter and ADS58C48 with Single-Tone Input at 170 MHz

Table 6. Analysis of FFT for PGA870 (G = 20 dB) + Second-Order Bandpass Filter and ADS58C48 at 170 MHz vs Typical ADC Specifications

CONFIGURATION	ADC INPUT	SNR	HD <sub>2</sub>	HD <sub>3</sub>
PGA870 + Second-order Bandpass Filter and ADS58C48	-1 dBFS	65 dBFS	-89.7 dBc	-90.8 dBc
ADS58C48 Only (typ)	-1 dBFS	66.1 dBFS	-82 dBc	-80 dBc

Figure 59 and Figure 60 show the FFT plots for the same second-order bandpass filter circuit with two-tone inputs, with each tone at  $-7$  dBFS and the PGA870 set to a gain of 20 dB. Figure 59 shows the FFT for two-tone inputs at 160 MHz and 170 MHz. The third-order intermodulation distortion products at 150 MHz and 180 MHz are less than  $-90$  dBc, though the second-order intermodulation distortion product at 10 MHz is at  $-82$  dBc. Figure 60 shows the FFT for two-tone inputs at 168 MHz and 170 MHz. The near-in third-order intermodulation products at 166 MHz and 172 MHz are less than  $-88$  dBFS, and the highest spur is the second-order intermodulation product at 2 MHz at  $-81$  dBFS.

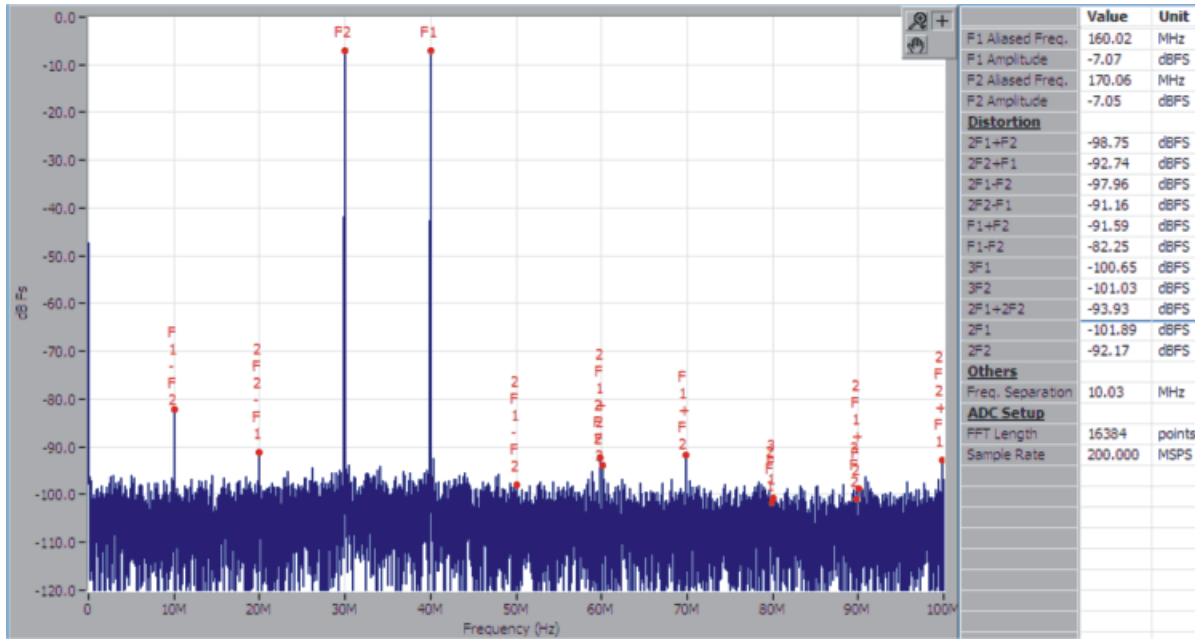

Figure 59. FFT Plot of PGA870 (G = 20 dB) + Second-Order Bandpass Filter and ADS58C48 with Two-Tone Inputs at 160 MHz and 170 MHz

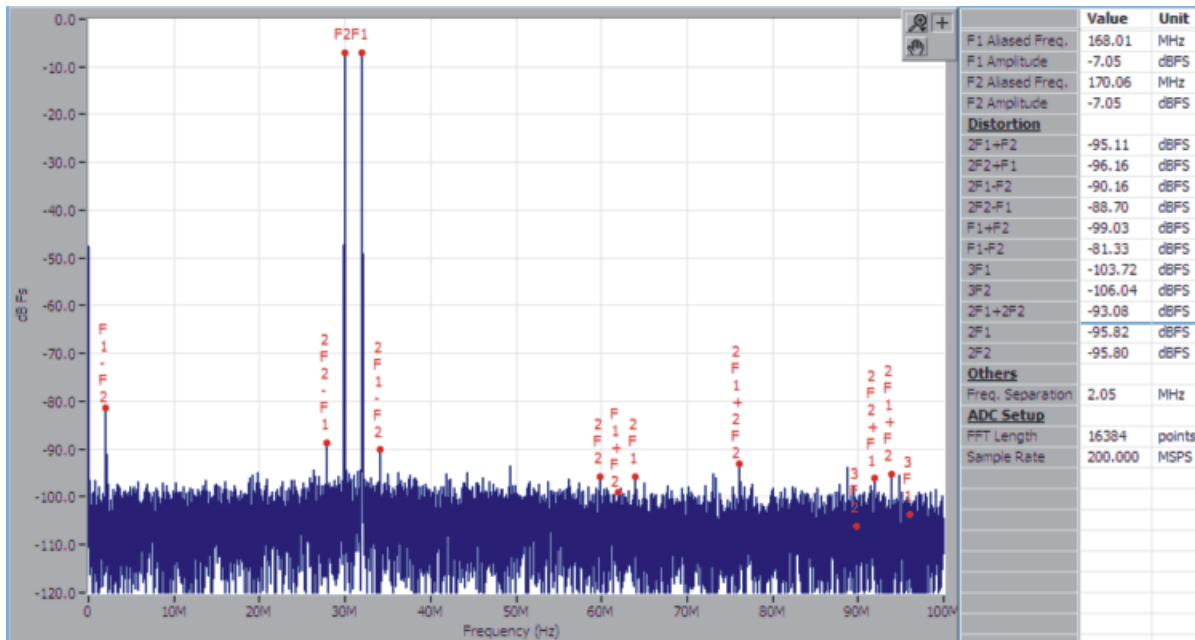

Figure 60. FFT Plot of PGA870 (G = 20 dB) + Second-Order Bandpass Filter and ADS58C48 with Two-Tone Inputs at 168 MHz and 170 MHz

## PCB Layout Recommendations

Complete information about the PGA870EVM is found in the [PGA870EVM User Guide](#), available for download through the [PGA870 product folder](#) on the TI web site. Printed circuit board (PCB) layout should follow these general guidelines:

1. Signal routing should be direct and as short as possible into and out of the device input and output pins. Routing the signal path between layers using vias should be avoided if possible.
2. The device PowerPAD should be connected to a solid ground plane with multiple vias. The PowerPAD must be connected to electrical ground. Consult the [PGA870EVM User Guide](#) for a layout example.
3. Ground or power planes should be removed from directly under the amplifier output pins.
4. A 0.1- $\mu$ F capacitor should be placed between the  $V_{MID}$  pin and ground near to the pin.
5. An output resistor is recommended in each output lead, placed as near to the output pins as possible.
6. Two 0.1- $\mu$ F power-supply decoupling capacitors should be placed as near to the power-supply pins as possible.
7. Two 10- $\mu$ F power-supply decoupling capacitors should be placed within 1 in (2,54 cm) of the device.
8. The digital control pins use CMOS logic levels for high and low signals, but can tolerate being pulled high to a +5-V power supply. The digital control pins do not have internal pull-up resistors.

## REVISION HISTORY

NOTE: Page numbers for previous revisions may differ from page numbers in the current version.

Changes from Original (December, 2009) to Revision A	Page
• Updated <a href="#">Related Products</a> table .....	1
• Changed storage temperature range specification in <a href="#">Absolute Maximum Ratings</a> table .....	2
• Moved <i>noise figure</i> parameter to <i>AC Performance</i> section of Electrical Characteristics ( $V_S = +5\text{ V}$ ) table .....	3
• Added <i>output-referred voltage noise</i> parameter to Electrical Characteristics ( $V_S = +5\text{ V}$ ) table .....	3
• Added <a href="#">Figure 31</a> .....	12
• Revised second paragraph of <a href="#">Single-Ended to Differential Operation</a> section .....	18
• Added new paragraph to <a href="#">Differential-to-Differential Operation</a> section .....	19
• Added <a href="#">Operation with Split Supply <math>\pm 2.5\text{V}</math></a> section .....	19
• Added <a href="#">Driving ADCs</a> section .....	20
• Added <a href="#">PGA870 Driving ADS58C48</a> section .....	24
• Added <a href="#">Testing the PGA870 with a First-Order Bandpass Filter</a> section .....	25
• Added <a href="#">Testing the PGA870 with a Second-Order Bandpass Filter</a> section .....	28

**PACKAGING INFORMATION**

Orderable Device	Status <sup>(1)</sup>	Package Type	Package Drawing	Pins	Package Qty	Eco Plan <sup>(2)</sup>	Lead/ Ball Finish	MSL Peak Temp <sup>(3)</sup>	Samples (Requires Login)
PGA870IRHDR	ACTIVE	VQFN	RHD	28	3000	Green (RoHS & no Sb/Br)	CU NIPDAU	Level-2-260C-1 YEAR	<a href="#">Purchase Samples</a>
PGA870IRHDT	ACTIVE	VQFN	RHD	28	250	Green (RoHS & no Sb/Br)	CU NIPDAU	Level-2-260C-1 YEAR	<a href="#">Request Free Samples</a>

<sup>(1)</sup> The marketing status values are defined as follows:

**ACTIVE:** Product device recommended for new designs.

**LIFEBUY:** TI has announced that the device will be discontinued, and a lifetime-buy period is in effect.

**NRND:** Not recommended for new designs. Device is in production to support existing customers, but TI does not recommend using this part in a new design.

**PREVIEW:** Device has been announced but is not in production. Samples may or may not be available.

**OBsolete:** TI has discontinued the production of the device.

<sup>(2)</sup> Eco Plan - The planned eco-friendly classification: Pb-Free (RoHS), Pb-Free (RoHS Exempt), or Green (RoHS & no Sb/Br) - please check <http://www.ti.com/productcontent> for the latest availability information and additional product content details.

**TBD:** The Pb-Free/Green conversion plan has not been defined.

**Pb-Free (RoHS):** TI's terms "Lead-Free" or "Pb-Free" mean semiconductor products that are compatible with the current RoHS requirements for all 6 substances, including the requirement that lead not exceed 0.1% by weight in homogeneous materials. Where designed to be soldered at high temperatures, TI Pb-Free products are suitable for use in specified lead-free processes.

**Pb-Free (RoHS Exempt):** This component has a RoHS exemption for either 1) lead-based flip-chip solder bumps used between the die and package, or 2) lead-based die adhesive used between the die and leadframe. The component is otherwise considered Pb-Free (RoHS compatible) as defined above.

**Green (RoHS & no Sb/Br):** TI defines "Green" to mean Pb-Free (RoHS compatible), and free of Bromine (Br) and Antimony (Sb) based flame retardants (Br or Sb do not exceed 0.1% by weight in homogeneous material)

<sup>(3)</sup> MSL, Peak Temp. -- The Moisture Sensitivity Level rating according to the JEDEC industry standard classifications, and peak solder temperature.

**Important Information and Disclaimer:** The information provided on this page represents TI's knowledge and belief as of the date that it is provided. TI bases its knowledge and belief on information provided by third parties, and makes no representation or warranty as to the accuracy of such information. Efforts are underway to better integrate information from third parties. TI has taken and continues to take reasonable steps to provide representative and accurate information but may not have conducted destructive testing or chemical analysis on incoming materials and chemicals. TI and TI suppliers consider certain information to be proprietary, and thus CAS numbers and other limited information may not be available for release.

In no event shall TI's liability arising out of such information exceed the total purchase price of the TI part(s) at issue in this document sold by TI to Customer on an annual basis.

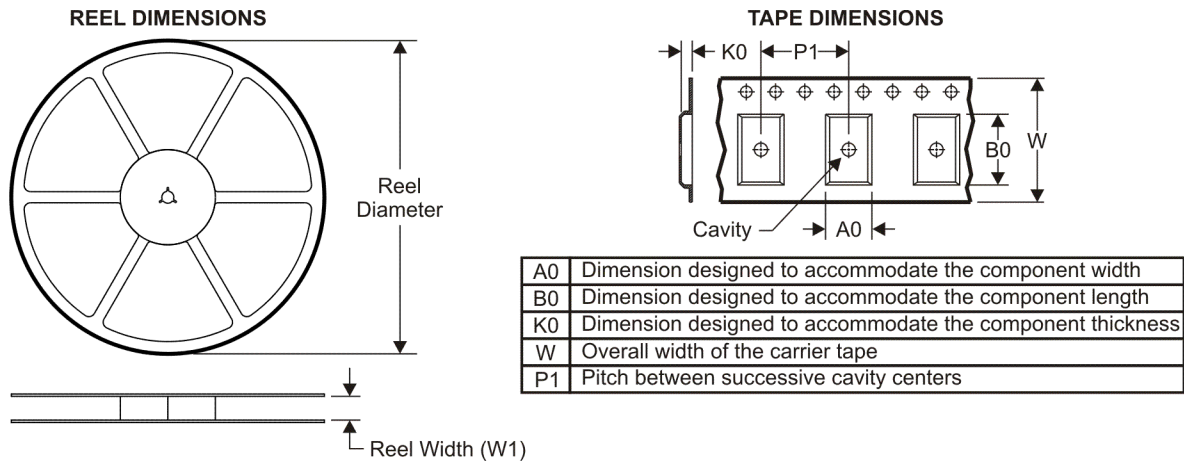
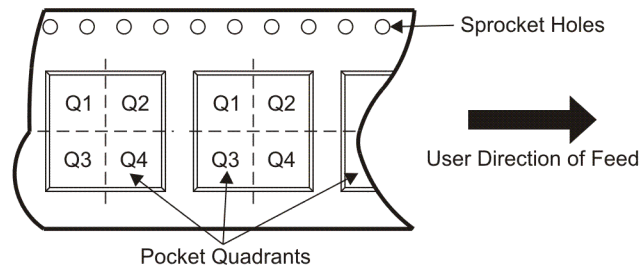
**TAPE AND REEL INFORMATION**

**QUADRANT ASSIGNMENTS FOR PIN 1 ORIENTATION IN TAPE**

\*All dimensions are nominal

Device	Package Type	Package Drawing	Pins	SPQ	Reel Diameter (mm)	Reel Width W1 (mm)	A0 (mm)	B0 (mm)	K0 (mm)	P1 (mm)	W (mm)	Pin1 Quadrant
PGA870IRHDR	VQFN	RHD	28	3000	330.0	12.4	5.3	5.3	1.5	8.0	12.0	Q2
PGA870IRHDT	VQFN	RHD	28	250	180.0	12.4	5.3	5.3	1.5	8.0	12.0	Q2

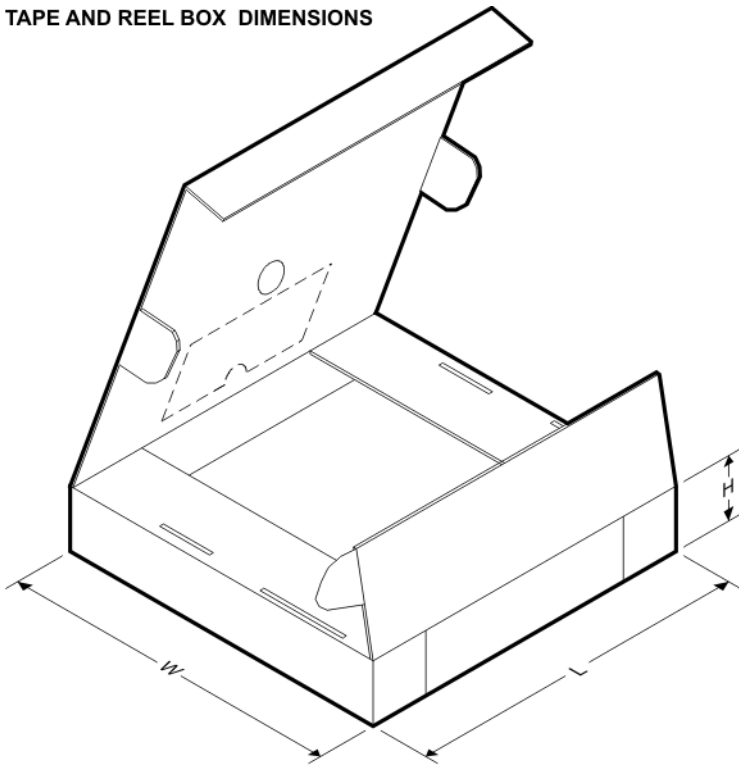
TAPE AND REEL BOX DIMENSIONS



\*All dimensions are nominal

Device	Package Type	Package Drawing	Pins	SPQ	Length (mm)	Width (mm)	Height (mm)
PGA870IRHDR	VQFN	RHD	28	3000	346.0	346.0	29.0
PGA870IRHDT	VQFN	RHD	28	250	190.5	212.7	31.8

# MECHANICAL DATA

RHD (S-PVQFN-N28)

PLASTIC QUAD FLATPACK NO-LEAD

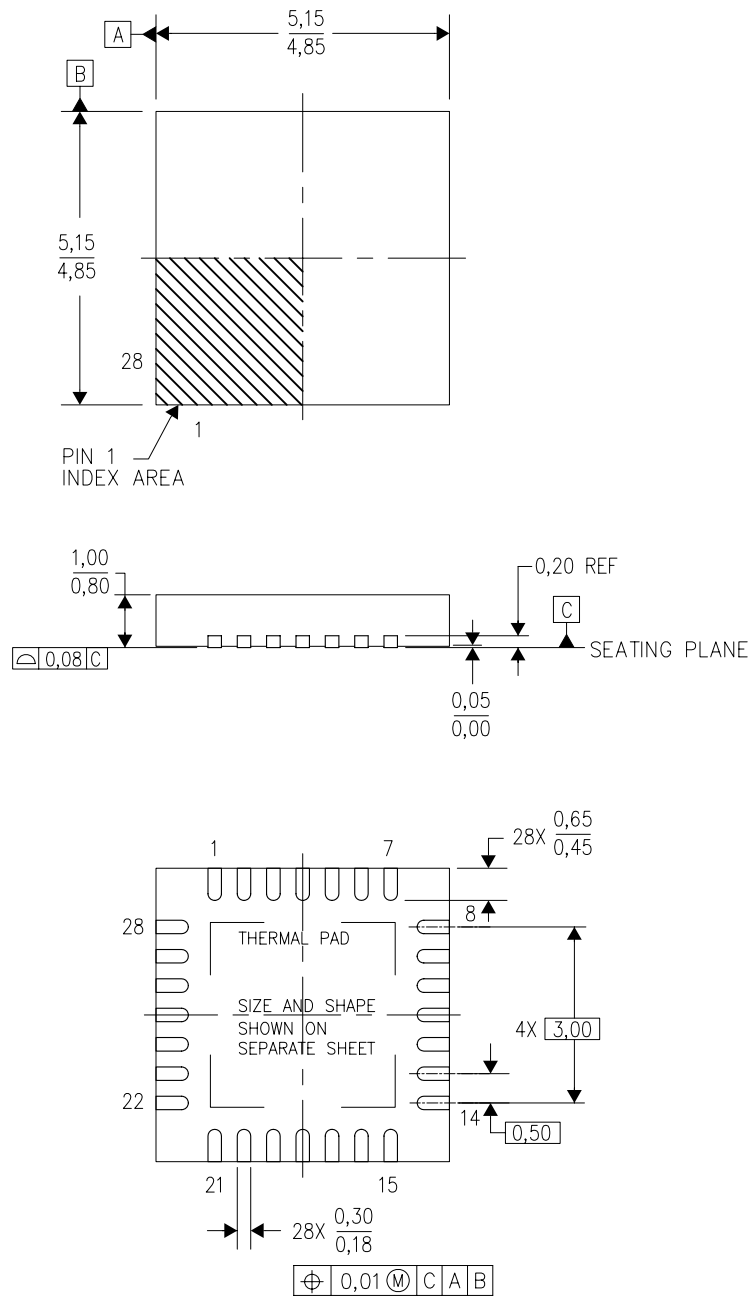

4204400/E 07/11

- NOTES:
- All linear dimensions are in millimeters. Dimensioning and tolerancing per ASME Y14.5M-1994.
  - This drawing is subject to change without notice.
  - QFN (Quad Flatpack No-Lead) Package configuration.
  - The package thermal pad must be soldered to the board for thermal and mechanical performance.
  - See the additional figure in the Product Data Sheet for details regarding the exposed thermal pad features and dimensions.
  - Falls within JEDEC MO-220.

## THERMAL PAD MECHANICAL DATA

RHD (S-PVQFN-N28)

PLASTIC QUAD FLATPACK NO-LEAD

### THERMAL INFORMATION

This package incorporates an exposed thermal pad that is designed to be attached directly to an external heatsink. The thermal pad must be soldered directly to the printed circuit board (PCB). After soldering, the PCB can be used as a heatsink. In addition, through the use of thermal vias, the thermal pad can be attached directly to the appropriate copper plane shown in the electrical schematic for the device, or alternatively, can be attached to a special heatsink structure designed into the PCB. This design optimizes the heat transfer from the integrated circuit (IC).

For information on the Quad Flatpack No-Lead (QFN) package and its advantages, refer to Application Report, QFN/SON PCB Attachment, Texas Instruments Literature No. SLUA271. This document is available at [www.ti.com](http://www.ti.com).

The exposed thermal pad dimensions for this package are shown in the following illustration.

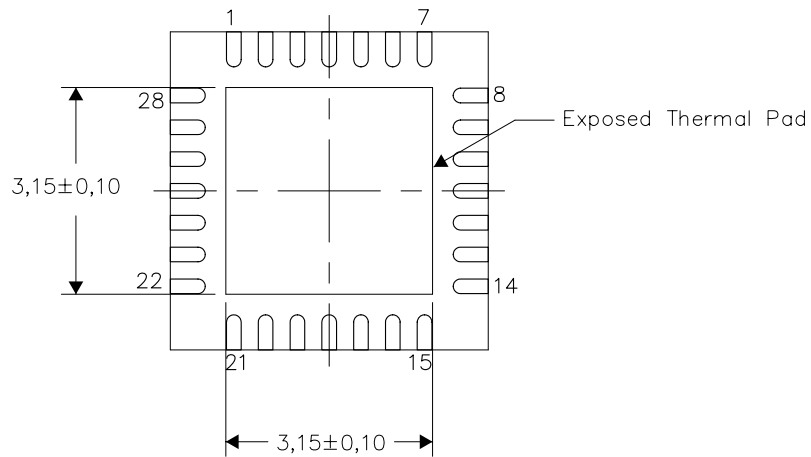

Bottom View

Exposed Thermal Pad Dimensions

4206358-2/1 05/11

NOTE: All linear dimensions are in millimeters



## IMPORTANT NOTICE

Texas Instruments Incorporated and its subsidiaries (TI) reserve the right to make corrections, modifications, enhancements, improvements, and other changes to its products and services at any time and to discontinue any product or service without notice. Customers should obtain the latest relevant information before placing orders and should verify that such information is current and complete. All products are sold subject to TI's terms and conditions of sale supplied at the time of order acknowledgment.

TI warrants performance of its hardware products to the specifications applicable at the time of sale in accordance with TI's standard warranty. Testing and other quality control techniques are used to the extent TI deems necessary to support this warranty. Except where mandated by government requirements, testing of all parameters of each product is not necessarily performed.

TI assumes no liability for applications assistance or customer product design. Customers are responsible for their products and applications using TI components. To minimize the risks associated with customer products and applications, customers should provide adequate design and operating safeguards.

TI does not warrant or represent that any license, either express or implied, is granted under any TI patent right, copyright, mask work right, or other TI intellectual property right relating to any combination, machine, or process in which TI products or services are used. Information published by TI regarding third-party products or services does not constitute a license from TI to use such products or services or a warranty or endorsement thereof. Use of such information may require a license from a third party under the patents or other intellectual property of the third party, or a license from TI under the patents or other intellectual property of TI.

Reproduction of TI information in TI data books or data sheets is permissible only if reproduction is without alteration and is accompanied by all associated warranties, conditions, limitations, and notices. Reproduction of this information with alteration is an unfair and deceptive business practice. TI is not responsible or liable for such altered documentation. Information of third parties may be subject to additional restrictions.

Resale of TI products or services with statements different from or beyond the parameters stated by TI for that product or service voids all express and any implied warranties for the associated TI product or service and is an unfair and deceptive business practice. TI is not responsible or liable for any such statements.

TI products are not authorized for use in safety-critical applications (such as life support) where a failure of the TI product would reasonably be expected to cause severe personal injury or death, unless officers of the parties have executed an agreement specifically governing such use. Buyers represent that they have all necessary expertise in the safety and regulatory ramifications of their applications, and acknowledge and agree that they are solely responsible for all legal, regulatory and safety-related requirements concerning their products and any use of TI products in such safety-critical applications, notwithstanding any applications-related information or support that may be provided by TI. Further, Buyers must fully indemnify TI and its representatives against any damages arising out of the use of TI products in such safety-critical applications.

TI products are neither designed nor intended for use in military/aerospace applications or environments unless the TI products are specifically designated by TI as military-grade or "enhanced plastic." Only products designated by TI as military-grade meet military specifications. Buyers acknowledge and agree that any such use of TI products which TI has not designated as military-grade is solely at the Buyer's risk, and that they are solely responsible for compliance with all legal and regulatory requirements in connection with such use.

TI products are neither designed nor intended for use in automotive applications or environments unless the specific TI products are designated by TI as compliant with ISO/TS 16949 requirements. Buyers acknowledge and agree that, if they use any non-designated products in automotive applications, TI will not be responsible for any failure to meet such requirements.

Following are URLs where you can obtain information on other Texas Instruments products and application solutions:

### Products

Audio	<a href="http://www.ti.com/audio">www.ti.com/audio</a>
Amplifiers	<a href="http://amplifier.ti.com">amplifier.ti.com</a>
Data Converters	<a href="http://dataconverter.ti.com">dataconverter.ti.com</a>
DLP® Products	<a href="http://www.dlp.com">www.dlp.com</a>
DSP	<a href="http://dsp.ti.com">dsp.ti.com</a>
Clocks and Timers	<a href="http://www.ti.com/clocks">www.ti.com/clocks</a>
Interface	<a href="http://interface.ti.com">interface.ti.com</a>
Logic	<a href="http://logic.ti.com">logic.ti.com</a>
Power Mgmt	<a href="http://power.ti.com">power.ti.com</a>
Microcontrollers	<a href="http://microcontroller.ti.com">microcontroller.ti.com</a>
RFID	<a href="http://www.ti-rfid.com">www.ti-rfid.com</a>
RF/IF and ZigBee® Solutions	<a href="http://www.ti.com/lprf">www.ti.com/lprf</a>

### Applications

Communications and Telecom	<a href="http://www.ti.com/communications">www.ti.com/communications</a>
Computers and Peripherals	<a href="http://www.ti.com/computers">www.ti.com/computers</a>
Consumer Electronics	<a href="http://www.ti.com/consumer-apps">www.ti.com/consumer-apps</a>
Energy and Lighting	<a href="http://www.ti.com/energy">www.ti.com/energy</a>
Industrial	<a href="http://www.ti.com/industrial">www.ti.com/industrial</a>
Medical	<a href="http://www.ti.com/medical">www.ti.com/medical</a>
Security	<a href="http://www.ti.com/security">www.ti.com/security</a>
Space, Avionics and Defense	<a href="http://www.ti.com/space-avionics-defense">www.ti.com/space-avionics-defense</a>
Transportation and Automotive	<a href="http://www.ti.com/automotive">www.ti.com/automotive</a>
Video and Imaging	<a href="http://www.ti.com/video">www.ti.com/video</a>
Wireless	<a href="http://www.ti.com/wireless-apps">www.ti.com/wireless-apps</a>

TI E2E Community Home Page

[e2e.ti.com](http://e2e.ti.com)

Mailing Address: Texas Instruments, Post Office Box 655303, Dallas, Texas 75265  
Copyright © 2011, Texas Instruments Incorporated